

# Gilian®



## **GilAir® PLUS**

### Operation Manual

***SENSIDYNE®***

*Industrial Health & Safety Instrumentation*

1000 112<sup>TH</sup> Circle N, Suite 100 • St. Petersburg, FL 33716 USA

(800) 451-9444 • +1 (727) 530-3602

[www.Sensidyne.com](http://www.Sensidyne.com) • [info@Sensidyne.com](mailto:info@Sensidyne.com)

REF 360-0132-01 (Rev T, Software version 2.4.0)

## GilAir Plus Identifiers:



**A** LCD Display

**B** Status and Notification LED's

**C** Inlet Filter

**D** Hi/Lo Control Valve

**E** Charging Contacts

**F** Belt Clip

**G** Battery Access Screws

**H** Power Port

**I** USB Port (On communication-enabled Docks)

**J** Reference Device Port (On communication-enabled Docks)

## Quality Policy Statement

---

***At Sensidyne, we are committed to providing products and services that consistently meet customer needs and comply with all applicable statutory and regulatory requirements.***

***Our products are designed, manufactured and calibrated in accordance with ISO 9001:2008, ISO/IEC 17025:2005, ISO/IEC 80079-34, ATEX Directive 94/9/EEC, and IECEx, where applicable. Through ongoing review of our designs, supplier performance, and customer feedback we strive to ensure continuous improvement.***

***All employees at Sensidyne share the responsibility to provide products that are produced efficiently and economically representing the best value to our customers. We are committed to meeting or exceeding customer expectations in everything we do.***

***Sensidyne, LP***

## Warranty

---

Sensidyne warrants that, at the time of delivery, the GilAir Plus shall be free of all defects in workmanship and material. Sensidyne will repair or replace, at its sole option, any GilAir Plus found to be defective by Sensidyne, if notified by Purchaser within the Warranty time period.

The warranty time period shall be for two (2) years from the date of original shipment by Sensidyne, except as noted below.

- A. Exceptions to the above two year warranty time period:
  - 1. The keypad of the GilAir Plus has a five (5) year warranty
  - 2. The rechargeable NiMH battery pack has a one (1) year warranty.
  - 3. Consumables have a ninety (90) day warranty.
  
- B. This warranty shall be null and void on any product which:
  - 1. Is operated or used in excess of the product's operating specifications; or
  - 2. is not properly maintained in accordance with its maintenance manual or specifications; or
  - 3. has been repaired or modified by persons other than authorized Sensidyne personnel or Factory Trained Service Centers, unless such work is authorized in advance in writing by Sensidyne; or
  - 4. has been damaged, abused, or misused.
  
- C. Warranty on Service and Repairs:
  - 1. Goods, which have been repaired or replaced during the warranty period, are warranted only for the remainder of the unexpired portion of the original warranty period.
  - 2. Repairs or service provided not pursuant to warranty: 180 days from date of shipment by Sensidyne.

**THIS WARRANTY IS IN LIEU OF ALL OTHER WARRANTIES, EXPRESSED OR IMPLIED, INCLUDING BUT NOT BEING LIMITED TO THE IMPLIED WARRANTIES OF MERCHANTABILITY AND FITNESS FOR USE FOR A PARTICULAR PURPOSE, WHICH ARE EXPRESSLY DISCLAIMED, AND CONSTITUTES THE ONLY WARRANTY OF SENSIDYNE WITH RESPECT TO GOODS SOLD OR DELIVERED.**

## Table of Contents

---

GilAir Plus Identifiers: .....	II
Quality Policy Statement .....	III
Warranty.....	IV
SECTION ONE: Preface .....	1
WARNINGS .....	3
Certifications, Approvals and Compliances .....	5
SECTION TWO: Introduction .....	6
2.1. Product Description .....	6
2.2. Pump Kit Descriptions .....	7
SECTION THREE: Set-Up .....	8
3.1. Preparation .....	8
3.2. Pump Start Up .....	8
3.2.1. Power Up .....	8
3.2.2. Startup sequence .....	8
3.2.3. Power Source Check .....	9
3.2.4. Power Down.....	9
3.3. Setting the Flow Rate .....	10
3.4. Power Options .....	10
SECTION FOUR: General Operation.....	11
4.1. Overview .....	11
4.2. Connections .....	11
4.3. Navigation .....	12
4.4. Menus.....	12
4.5. Displays.....	14
4.5.1. Display Details .....	16
4.5.2. Menu Details .....	16
4.5.3. Idle Display Details.....	16
4.5.4. Constant Flow Run Display Details .....	17
4.5.5. Constant Pressure Display Details .....	17
4.5.6. Fault Display Details .....	18
4.5.7. Program Display.....	18
4.5.8. STP Display .....	18

4.5.9.	Barometric Compensation Display .....	19
4.6.	Sensor Calibration .....	20
4.7.	Run Mode .....	20
4.7.1.	Run Mode Descriptions .....	20
4.7.2.	Locking the Keypad .....	21
4.7.3.	Unlocking the Keypad .....	21
4.8.	Flow Set (cc/min) .....	23
4.8.1.	Setting the Flow Rate Range .....	23
4.8.2.	Setting the Flow Rate .....	24
4.9.	Field Calibrate .....	24
4.9.1.	Field Calibration .....	24
4.9.2.	Calibration Option (SmartCal <sup>SM</sup> ) .....	25
4.9.3.	Displayed Flow Calibration .....	26
4.10.	Fault Condition Cause and Displays .....	27
	SECTION FIVE: Options .....	29
5.1.	Setup ► .....	29
5.2.	Event ID Enable .....	29
5.3.	Pre/Post-Calibration .....	30
5.4.	User Mode .....	32
5.5.	Power-on Run .....	32
5.6.	Event Lock .....	32
5.7.	EN13137 .....	32
5.8.	Fault Retry .....	33
5.9.	Valve Mode .....	33
5.10.	SmartCal <sup>SM</sup> Automatic Calibration .....	33
5.10.1.	Gilibrator-2 .....	34
5.10.2.	Challenger® .....	36
5.10.3.	TSI™ Model 4146 and Sensidyne Go-Cal .....	37
5.10.4.	Bios Defender™ 510, 520, 530 .....	38
5.11.	Clear Datalog .....	39
5.12.	Run Options ► .....	40
5.12.1.	Standard Temperature (STP Models only) .....	40
5.12.2.	Standard Pressure (mmHg) (STP models only) .....	40
5.12.3.	Sensor Option .....	41

5.12.4. PaTa compensation (STP models only, in high flow) .....	41
5.13. Display Options ► .....	42
5.13.1. Language .....	42
5.13.2. Temperature Units .....	42
5.13.3. Pressure Units.....	43
5.14. Clock Set ► .....	43
5.14.1. Clock .....	43
5.14.2. Date .....	44
5.14.3. Time Format.....	44
5.14.4. Date Format .....	45
5.15. Password.....	45
5.16. Control Mode .....	46
5.17. Run Mode: Manual, Timed, Vol, RT and Program name .....	47
5.18. Run Setup ► .....	48
5.18.1. Timed Start (T/V/R start) .....	48
5.19. Timed Duration .....	49
5.20. Vol Set.....	49
5.21. RT.....	49
5.22. Pressure Set ("H <sub>2</sub> O, mmHg, KPa or mbar).....	50
SECTION SIX: Programming .....	51
6.1. Program ► .....	51
6.2. Program Edit ► .....	52
6.3. Program Name .....	53
6.4. Control Mode .....	53
6.5. Set the Flow Rate or Pressure.....	53
6.6. Program Steps.....	54
6.7. Function.....	54
6.8. Function Value.....	55
6.9. Save a Program.....	56
6.10. Review Events.....	56
SECTION SEVEN: PC Interface .....	58
7.1. PC Interface.....	58
SECTION EIGHT: Maintenance Menu .....	59
8.1. Maintenance ► .....	59

8.2.	Global Reset.....	59
8.2.1.	Reset (save programs).....	61
8.2.2.	Clear Datalog .....	62
8.3.	T ambient Cal ► .....	63
8.4.	Barometric P Cal ► .....	64
8.5.	Pressure ► .....	65
8.6.	Power Source .....	66
8.7.	Contrast.....	66
	SECTION NINE: User Maintenance.....	67
9.1.	NiMH Battery Maintenance and Reconditioning .....	67
9.2.	Battery Replacement .....	68
9.3.	Pump Filter Maintenance.....	68
	SECTION TEN: Appendices .....	70
	Appendix A: Menu Outline.....	71
	Appendix B: Example Program Setup & Edit .....	73
	Appendix C: Barometric Compensation .....	80
	Appendix D: Dual Port High/Low Flow Manifold .....	81
	Appendix E: Troubleshooting Guide.....	83
	Appendix F: Parts List .....	87
	Appendix G: Specifications .....	92
	Appendix H: Charging/Communications Dock .....	95
	Appendix I: Factory Calibration and Service .....	100



## SECTION ONE: Preface

---

### Proprietary Notice

The intended use of this manual is exclusive to owners of Gilian GilAir Plus air sampling pumps. The material within this manual is proprietary information and is to be used only to understand, operate, and service the instrument. By receiving this document, the recipient agrees that neither this document, the information disclosed within, nor any part thereof shall be reproduced or transferred, physically, electronically or in any other form or used or disclosed to others for manufacturing or for any other purpose except as specifically authorized in writing by Sensidyne, LP.

### Copyright Notice

© 2015 Sensidyne, LP All Rights Reserved. Reproduction, transmittal, transcribing, storing in a retrieval system or translation of this document in part or in its entirety is strictly prohibited without the prior written permission of Sensidyne, LP.

### Trademark Notice

Sensidyne, the Sensidyne logo, Gilian, Gilian GilAir, GilAir, and GilAir Plus names and logos are registered trademarks of Sensidyne, LP. Other trademarks and service marks used in this document are the property of their respective companies and are used only for informational and explanatory purposes.

### Firmware/Software License

The firmware and the associated PC application software installed in or provided with the GilAir Plus pump is the property of Sensidyne, LP and shall remain the property of Sensidyne, LP in perpetuity. The firmware/software is protected by U.S. and international copyright laws and is licensed for specific use with the Gilian GilAir Plus pump. The user may NOT reverse-engineer, disassemble, decompile, or make any attempt to discover the source code of the firmware/software. The firmware/software may NOT be translated, copied, merged or modified in any way. The user may NOT sublicense, rent, or lease any portion of the firmware/software. The right to use the firmware/software terminates automatically if any part of this license is violated.

## Disclaimer

**THE SELLER ASSUMES NO RESPONSIBILITY WHATSOEVER, TO ANY PARTY WHOSOEVER, FOR ANY PROPERTY DAMAGE, PERSONAL INJURY, OR DEATH RECEIVED BY OR RESULTING FROM, IN WHOLE, OR IN PART, THE IMPROPER USE, INSTALLATION, OR STORAGE OF THIS PRODUCT BY THE USER, PERSON, FIRM, ENTITY, CORPORATION OR PARTY NOT ADHERING TO THE INSTRUCTIONS AND WARNINGS IN THIS MANUAL, OR OTHERWISE PROVIDED BY THE SELLER OR FROM NOT ADHERING TO ALL FEDERAL, STATE, AND LOCAL ENVIRONMENTAL AND OCCUPATIONAL HEALTH AND SAFETY LAWS AND REGULATIONS.**

**THE SELLER SHALL NOT BE LIABLE FOR DIRECT, INDIRECT, CONSEQUENTIAL, INCIDENTAL OR OTHER DAMAGES RESULTING FROM THE SALE AND USE OF ANY GOODS AND SELLER'S LIABILITY HEREUNDER SHALL BE LIMITED TO REPAIR OR REPLACEMENT OF ANY GOODS FOUND DEFECTIVE.**



## WARNINGS

### **READ AND UNDERSTAND ALL WARNINGS AND INSTRUCTIONS BEFORE USE.**

Failure to read, understand, and comply with ALL accompanying literature, instructions, product labels, and warnings could result in property damage, severe personal injury, or death.

Read and understand ALL applicable environmental health and safety laws and regulations before operating this product. Ensure complete compliance with ALL applicable laws and regulations before and during the use of this product.

DO NOT remove, cover, or alter any label or tag on this product, its accessories, or related products.

UNDER NO CIRCUMSTANCES should this product be used except by qualified, trained and technically competent personnel.

The GilAir Plus portable air sampling pump is intended for both indoor and outdoor use. The unit is not waterproof. NEVER submerge the unit in water. Pump failure, faulting or user injury may result.

The GilAir Plus Pump is Intrinsically Safe when used with specified battery pack part number 783-0012-01-R. Refer to the Certifications and Approvals section for approval ratings. **Due to risk of static charge, do not clean the pump labels or keypad with a dry cloth in areas where acetylene may be present.**

DO NOT operate this product should it malfunction, require repair, or have a cracked or broken case or other visible or known damage.

DO NOT repair or modify this product, except as specified in this Operation Manual. All user controls and adjustments are made via the sealed keypad on the front of the pump and the Hi/Lo control valve. The only user-replaceable parts are the Battery Pack and Pump Filter. (See Sections 9.2. and 9.3. )

Use ONLY specified Sensidyne parts when performing maintenance procedures described in this manual. Intrinsic safety certifications become void by substitution of unauthorized components, unauthorized repair or alteration. All other Service should be performed by Sensidyne Authorized Service Departments only. (See Appendix F for Parts List; see Appendix I for Service Contact Information).

This product uses rechargeable Nickel Metal Hydride (NiMH) batteries. **Always fully charge before use.** DO NOT attempt to deeply discharge the pump battery pack.

**DO NOT open the pump case, charge or replace batteries in an explosive atmosphere.** Use only battery pack and Dock specified in the Parts List. DO NOT operate pump while charging. **Caution:** Both Dock and battery may become warm during charging.

This product offers an optional battery configuration that will accept over-the-counter alkaline, lithium, or rechargeable NiMH batteries. **The GilAir Plus is not intrinsically safe when used in this configuration and should not be used in explosive atmospheres when using this optional battery configuration.**

If the GilAir Plus pump comes into contact with a destructive substance(s) it is the responsibility of the user to take suitable precautions that prevent the pump from being adversely affected, thus ensuring that the Intrinsic Safety protection is not compromised. Destructive substances include acidic liquids or gases that may attack metals, solvents that may affect polymeric materials, other solvents, or corrosives. Suitable precautions are regular checks as part of routine inspections and establishing from material data sheets that chemicals known to be present do not have an adverse effect on the material of the pump (polycarbonate, polyester, silicone, Buna-N, Neoprene, Stainless steel, brass and epoxy).

DO NOT operate with a dirty or blocked inlet filter or kinked tubing. Pump failure or faulting may result.

# Certifications, Approvals and Compliances

## Declaration of Conformity



### DECLARATION OF CONFORMITY

Sensidyne, LP  
 1000 112<sup>th</sup> Circle North, Suite 100  
 St. Petersburg, Florida 33716

Certificate No: 001 Issue 6 November 19<sup>th</sup>, 2014

The undersigned declares that the products named in this certificate meet the provisions of the European Communities Council Directive 94/9/EC (ATEX) concerning equipment and protective systems intended for use in potentially explosive atmospheres and US and Canadian Hazardous Location and Electrical Equipment Requirements.

Product Type: Portable Air Sampling Pump  
 Product designation: Gilair Plus with 7.2 V DC NiMH Battery Pack  
 Manufacturer : Sensidyne, LP  
 Intended Use: Air Sampling

Notified Body: FM Approvals Ltd. Notified body Number: CE 1725  
 1 Windsor Dials  
 Windsor  
 Berkshire  
 UK SL4 1RS

**Intrinsically Safe:**

**US**  
 Class I, II, III Division 1, Groups: A, B, C, D, E, F, and G, hazardous (classified) locations.  
 IS/I,II,III /I/ ABCDEFG / T4 ta = 0°C to 45°C  
 Class I, Zone 0, Group: IIC hazardous (classified) locations.  
 I / 0 AEx ia IIC /T4 Ta = 0°C to 45°C

Class 3600	2011
Class 3610	2010
ANSI/IEC 60529	2004

**CAN**  
 Class I, II, III Division 1, Groups: A, B, C, D, E, F, and G, hazardous (classified) locations.  
 IS/I,II,III /I/ ABCDEFG / T4 ta = 0°C to 45°C  
 Class I, Zone 0, Group: IIC hazardous (classified) locations.  
 I / 0 AEx ia IIC /T4 Ta = 0°C to 45°C

CAN C22.2 No. 157	2006
CAN C22.2 No. 213	2004
CSA-C22.2 No. 60529	2005

**EC** FM10ATEX0044X  
 II 1 G Ex ia IIC T4 Ta = 0°C to 45°C  
 Conforming to the following standards:  
 EN60079-0:2006  
 EN60079-11:2007  
 EN60079-26:2007  
 Report: 3039791EC

ATEX Quality Assurance Notification: SIRA Certification Notified body Number: 0518

EMC: Emissions and Immunity Standards

EN 61326:2006 EN 55011: Class A	EN 61000-4-5
EN 61000-4-2	EN 61000-4-6
EN 61000-4-3	EN 61000-4-8
EN 61000-4-4	EN 61000-4-11

Reference Product Safety Engineering Report 10162

Safety Compliance: TUV NRTL: U8 11 03 71335-002  
 CSA/CAN C22.2 No. 61010-1-04  
 UL 61010-1:2001:2005  
 EN 61010-1  
 Report: 090-1002842-000

Additional Standards:  
 EN1232 Type P  
 ISO 13137:2013 Type P and Type G (with version 2.4 firmware and labelled per 13137)

Signed: Date: Nov 19, 2014

Name: Bob Madeiros  
 Title: Manager: Quality Assurance /Regulatory Affairs Sensidyne, LP

Who is the natural and legal person with responsibility for the design, manufacture, packaging and labeling before the device is placed on the market under his own name, regardless of whether these operations are carried out by the Manufacturer or on his behalf by a third party.



A company of the **SCHAUENBURG** International Group

## SECTION TWO: Introduction

---

### 2.1. Product Description

The GilAir Plus is an advanced personal air sampling pump system available in three models: a basic model, a datalogging pump (DL) model, and standard temperature and pressure (STP) model. The STP model corrects the display flow rate and air volume to standard conditions of temperature and pressure. The STP model can also correct pump flow rate to keep flow constant with changes in barometric pressure and ambient temperature.

Pump Model	Flow Rate 1 to 5100 cc/min	Constant Flow & Constant Pressure	Battery Options NiMH, Alkaline & DC	Simple Program Functions (Timer Only)	Advanced Program Functions	Datalogging & Transfer to PC	Automatic Calibration Option (SmartCal)	Standard Temp & Pressure Data
Basic	✓	✓	✓	✓			✓*	
Datalog	✓	✓	✓	✓	✓	✓	✓	
STP	✓	✓	✓	✓	✓	✓	✓	✓

All models offer constant flow modes and constant pressure control modes. The Constant Flow Mode holds the set flow constant against changing backpressure within 5% or 3 cc/min whichever is larger. The Constant Pressure Mode holds the pressure constant when taking samples using constant resistance sampling trains. The constant pressure (multi-flow) mode allows the air stream to be split into two or more separate samples so that multiple samples can run at the same time. (See Appendix D for information on the dual port manifold) Furthermore, all models offer a built-in low constant flow mode, such that flow rates are attainable from 20 cc/min to 5100 cc/min without the addition of an external low flow adapter. Operation down to 1 cc/min is possible in the constant pressure mode. Additionally, all models offer start-stop programmability. A matrix chart for the available pump models are shown above.

**\*Note:** SmartCal<sup>SM</sup> Automatic calibration is only available on all pump models when used with a communications-enabled Dock. The **standard** Dock that comes with the basic pump does not have communication capability and will not support the SmartCal feature.

## 2.2. Pump Kit Descriptions

Kits are available in one, three and five pump configurations, with power cords in US, Euro and UK versions. A matrix chart for the available kits are provided below.

Kit Type	GilAir Plus Pump	Dock	Carrying Case	Filter Cassette Holder	Charcoal Tube Holder	CD with Software and Manual / Printed Manual
<b>Single Starter Kit</b>						
Basic	1	Single-Station Standard	No	1	1	1/1
Datalog (DL)	1	Single-Station with Communication	No	1	1	1/1
STP	1	Single-Station with Communication	No	1	1	1/1
<b>Three-Pack Starter Kit</b>						
Basic	3	Three-Station Standard	Yes	3	3	1/1
Datalog (DL)	3	Three-Station with Communication	Yes	3	3	1/1
STP	3	Three-Station with Communication	Yes	3	3	1/1
<b>Five-Pack Starter Kit</b>						
Basic	5	Five-Station Standard	Yes	5	5	1/1
Datalog (DL)	5	Five-Station with Communication	Yes	5	5	1/1
STP	5	Five-Station with Communication	Yes	5	5	1/1

See Appendix F for part numbers for pumps, kits and accessories.



## SECTION THREE: Set-Up

---

### 3.1. Preparation

The package includes the pump, Dock, Dock power supply, and a line cord. The Dock serves as the charging base for all models and the communications Dock for the datalogging and STP models.

Plug the power supply into the Dock and the AC power cord into the power supply. Connect the AC power cord to mains supply. The supply can accept 100-240 VAC at 50 or 60 Hz.

The pump arrives fully assembled.

### IMPORTANT

Before proceeding, you **MUST** charge the battery to full capacity prior to using the pump. To charge the pump, place it onto the charging base. The pump's belt clip secures the pump in place. Connection is made via contact points on both sides of the belt clip.

Allow up to five hours for a complete charge. A red LED on the pump indicates charging in progress; a green LED indicates charged and ready for use. The green LED will flash during top off charge and is on constantly while on trickle charge. For more information on charging, see Appendix H.

### 3.2. Pump Start Up

#### 3.2.1. Power Up

Power pump on by pressing and holding down (about 2 seconds) the  button until the pump turns on.

#### 3.2.2. Startup sequence

As the pump starts it goes through a number of phases that check for correct pump operation and special situations at startup.

Startup Phases:

- 1. Power verification:** Before starting the voltage from the power source (battery or DC) must be more than 6.3v. A display screen notifies the user when the voltage is low and displays the voltage. This typically occurs when a deeply discharged battery is placed on the Dock during the initial charge phase to bring the battery to adequate voltage for powering the system.



2. **Dock position determination:** When starting up on a Dock, the system pauses briefly to let the Dock provide the Dock position for use with the PC App. If no position is available after 45 seconds, a message appears asking the user to reseat the Dock.
3. **Serial number display:** The next display shows the product type (Basic, Datalog or STP), the serial number and the software revision for about 5 seconds.
4. **System initialization:** During system initialization the memory is read and checked for validity in the following sections.

**Datalog Index:** Datalog is checked for validity and the index is created. The number displayed is the number of events in the datalog

**Calibration:** The system calibrations are checked for validity.

**Point Cal:** Flow calibrations are checked for validity.

**System setup:** The block of memory containing the user set parameters is checked for validity.

**Programs:** The user program area is checked for validity.

5. **Date Check/Set:** If the current system date and time is earlier than the last date/time stored, this message appears to remind that the date should be reset.

### 3.2.3. Power Source Check

When the pump is charging on the Dock and the Dock status is being displayed, the charge status reported from the Dock is compared to the type of battery that is installed on the pump. If there is a discrepancy, the pump will signal the user by flashing the backlight and show a message asking for the pump to be removed. This is done to prevent the Dock from charging the battery in an inappropriate manner, which could result in the battery not being charged or being overcharged.

### 3.2.4. Power Down

Turn power off from any display when the pump is not running by pressing and holding down the  button. After approximately two seconds a power down display will appear and a five second shutdown sequence will start. If the button is released before the shutdown sequence is complete the power will not switch off. At the termination of the shutdown sequence, power is off.

**Note: Power cannot be shut down if a sample or program is running.**

### 3.3. Setting the Flow Rate

On the main menu, use the  button to move the cursor to **Flow Set**. Adjust the flow rate to the desired value using the  and  buttons. Press and release the  button to confirm the change.

### 3.4. Power Options

The GilAir Plus comes standard with a rechargeable nickel metal hydride (NiMH) battery pack. The unit is charged through the Dock that is included with all starter kits.

An optional alkaline battery pack (P/N 783-0013-01-R) is available that allows the use of over-the-counter AA batteries.

A third option, the DC power pack (783-0014-01-R) allows extended run times with the pump on the Dock for pumps with firmware versions up to revision 2.4. Pumps that have firmware version 2.4 or higher are supplied version 3.5 Docks that support running for extended periods of time while charging on the Dock without the need for the separate DC power pack.

**Note:** Do not attempt PC communications with the Dock, when running a sample, calibrating, or editing pump settings.

**Warning:** *Alkaline batteries, lithium batteries and the DC power pack should only be used in non-hazardous areas. Intrinsic safety certifications are only valid when using the rechargeable NiMH battery pack.*

## SECTION FOUR: General Operation

---

### 4.1. Overview

The GilAir Plus has the capability of generating and controlling flow over the range of 20 cc/min to 5100 cc/min in two flow ranges, 20-445 cc/min, and 450-5100 cc/min, that are selectable using a 2 mm or 5/64 inch hex key (provided with the pump). The actual flow is measured and controlled by the pump's internal processor. Flow control is provided directly in the constant flow mode. Pressure control is provided in the constant pressure control mode, which controls flow indirectly. During a sampling event the flow rate is displayed in the constant flow mode and backpressure is displayed in the constant pressure mode. Pump flow is not displayed in the constant pressure mode. The STP models measure the ambient temperature and pressure and can correct sample volumes and flows to Standard conditions. Standard temperature and pressure can be set to desired values. In addition, if enabled, the flow rate can be compensated for changes in temperature and pressure from the calibration point, holding the calibration value against altitude induced variability. (Appendix C)

### 4.2. Connections







Sample media is connected to the inlet port using ¼ inch ID tubing. Adapters that cause high pressure drop or using smaller diameter tubing may affect the sample flow. Minimize pressure drop in tubing and fittings and avoid any condition that will exceed the pump backpressure specifications (see Appendix E). The input port is part of the input manifold that provides input connection, output connection and contains a filter that protects the pump from contamination by particulates if operated without an effective sampling filter. This filter is user replaceable and should be replaced if discolored, clogged or obstructed in any way.

An output adapter accommodates filling sample containers such as Tedlar or Kynar sampling bags. Connect the bag fill adapter as shown below. The connection is sealed with a precision taper and should be inserted only finger tight. The knurled handle will not seat flush to the surface of the pump and should not be forced. The sample bag attaches with ¼ inch ID tubing. If the pressure in the bag increases, such as when it is completely filled, the pressure increase will be shown as increased pump backpressure and will terminate the event if the backpressure specification is exceeded.





### 4.3. Navigation

The GilAir Plus pump uses an intuitive six-button keypad for menu navigation and pump operation. The buttons and their functions are summarized in the table below.

Symbol	Name	Function
	Power/Enter	Powers the unit up or down, and enters a menu or confirms a parameter change
	Escape	Exits a menu
	Up Arrow	Select display screen options or move cursor up menu
	Down Arrow	Select display screen options or move cursor down menu
	Increase	Adjusts a parameter to higher values
	Decrease	Adjusts a parameter to lower values







### 4.4. Menus

The operation of the pump is controlled by entering the menu system and selecting the menu item that performs the desired function. The menu has submenus that allow control of related functions. A quick reference menu outline appears in Appendix A.







When the menu is not displayed, the  and  buttons select among the display screen options. The display screens are automatically selected by the pump whenever the mode of operation is changed (example: when an event is started or a fault occurs). The display screens include the **Idle** display, the **Constant Flow** control operating display, the **Constant Pressure** control operating display, the **Fault** display, **Program Status** display and **STP Display** (STP Models only). A description of the data displayed on each menu screen is contained in the Displays section (Section 4.5. ) of this manual.









**Sampling events:** The GilAir Plus accumulates sample data on events. An event is a sample run. The data for each sample event is stored as the event progresses so that no data loss is possible. When a sample is started, the event data is cleared to begin the new event. As the pump samples, the flow is controlled at the event flow rate or pressure depending on the selected control mode. The event data (time, flow, volume, backpressure and other information) is stored into nonvolatile memory.

If the pump is paused the event is not terminated. When the event continues, volume and time accumulation continue in the same event. If the event is stopped, the run data is available for review (Section 6.10. ) and in the idle screen until another event is started. The data from the last 16 events is available in the data review menu.

**General operation of the menu system:** Access the menu by pressing the  button. The menu is displayed in a vertical column. Some menu items have a ► sign after the menu item and lead to submenus. When the selected menu has the ►, pressing the  button enters the submenu. Pressing the  button exits the submenu and returns to the higher level menu. If a parameter is displayed at the right end of the line, the  and  buttons may be used to adjust the parameter up and down. If a parameter is changed it will be retained only if the  button is pressed to confirm the change. If a parameter has been changed, an ▲ symbol (for an increase in the parameter), or a ▼ symbol (signifying a decrease) is displayed to alert that the  button is required to confirm the change.



If the menu selection is altered with the  or  buttons without confirmation with the  button, the parameter will revert to its original value.

If the value is numeric, the  and  buttons alter the numeric value. If the parameter is a selection, the buttons will select each option in sequence. The option may require the  and  buttons to select. For instance, the “enable” selection is always made by the  button and the disable option is selected with the  button.

**NOTE:** Several parameters have numeric values, allowing the user to scroll through the entire range by simply pressing and holding down either the  and  buttons. In addition to this feature after pressing and holding the  or  button, the  and  buttons will accelerate the rate of scrolling. The  button moderately and the  button quickly accelerates the rate.

## 4.5. Displays

The display screens include the **Menu** display, **Idle** display, **Constant Flow** control operating display, **Constant Pressure** control operating display, **Fault** display, and the **Program Status** display. All displays include; the top status line displaying the Date, Time, and lock status; bottom status line displays the Battery type and charge status, Operating range (Hi or Lo), Control Mode (CF, CPL or CPH), and Run Mode (Manual, Timed, or Program).

Displays	Description												
<p style="text-align: center;"><b>Menu Display</b></p> <div style="border: 1px solid black; padding: 5px;"> <p>Jun 21, 2011      1:37PM</p> <hr/> <p>▶Run Flow set(cc/min)    5000 Calibrate Setup ▶</p> <hr/> <p>N  Hi    CF/MAN</p> </div>	<p>The main menu allows all of the parameters of the operation of the GilAir Plus to be set, by scrolling to the appropriate menu item (Section 4.3. )</p>												
<p style="text-align: center;"><b>Idle</b></p> <div style="border: 1px solid black; padding: 5px;"> <p>Jun 21, 2011      1:37PM</p> <hr/> <p>Flow set(cc/min)    1500 Volume(L)            286.401 Run time(min)        190 Datalog Events 16: 2.8%</p> <hr/> <p>N  Hi    CF/MAN</p> </div>	<p>Shown when the pump is not conducting an event or in the main menu, Idle displays Flow Set Point, Total Sample Volume, Run Time and the number of events stored and the percentage of the datalog memory used.</p>												
<p style="text-align: center;"><b>Constant Flow</b></p> <div style="border: 1px solid black; padding: 5px;"> <p>Jun 21, 2011      1:37PM</p> <hr/> <table style="width: 100%; border-collapse: collapse;"> <tr> <td style="width: 30%;">Flow cc/min</td> <td style="width: 20%;">BP</td> <td style="width: 50%;">0"</td> </tr> <tr> <td style="font-size: 2em; font-weight: bold;">2600</td> <td>V</td> <td>18.605L</td> </tr> <tr> <td></td> <td>RT</td> <td>7m</td> </tr> <tr> <td></td> <td>PRT</td> <td>48.3h</td> </tr> </table> <hr/> <p>N  Hi    CF/MAN</p> </div>	Flow cc/min	BP	0"	2600	V	18.605L		RT	7m		PRT	48.3h	<p>Displays Actual Flow rate (cc/min), Backpressure BP (inches water, mmHg, KPa or mbar), Total Sample Volume V (Liters), Run Time RT (minutes) and Projected Run Time PRT (hours), based on battery charge status and backpressure.</p>
Flow cc/min	BP	0"											
2600	V	18.605L											
	RT	7m											
	PRT	48.3h											



<p style="text-align: center;"><b>Constant Pressure</b></p> <table border="1" style="width: 100%;"> <tr> <td colspan="2">Jun 21, 2011</td> <td colspan="2">1:37PM</td> </tr> <tr> <td>BP "H2O</td> <td colspan="2" rowspan="2" style="font-size: 2em; text-align: center;"><b>18.0</b></td> <td>RT 8m</td> </tr> <tr> <td></td> <td>PRT 48.3h</td> </tr> <tr> <td colspan="2">N  Hi</td> <td colspan="2">CPH/MAN</td> </tr> </table>	Jun 21, 2011		1:37PM		BP "H2O	<b>18.0</b>		RT 8m		PRT 48.3h	N  Hi		CPH/MAN		<p>Displays Backpressure BP (inches water, mmHg, KPa, mbar), Run Time RT (minutes) and Projected Run Time PRT (hours) based on battery charge status and backpressure.</p>										
Jun 21, 2011		1:37PM																							
BP "H2O	<b>18.0</b>		RT 8m																						
			PRT 48.3h																						
N  Hi		CPH/MAN																							
<p style="text-align: center;"><b>Fault'</b></p> <table border="1" style="width: 100%;"> <tr> <td colspan="2">Jun 21, 2011</td> <td colspan="2">12:37PM</td> </tr> <tr> <td>Fault</td> <td>RT:</td> <td colspan="2">1m</td> </tr> <tr> <td>FC: 0</td> <td>FT:</td> <td colspan="2">21s</td> </tr> <tr> <td>Current:FC:OP:</td> <td>:</td> <td>:</td> <td>:</td> </tr> <tr> <td>Last: FC:</td> <td>:</td> <td>:</td> <td>:</td> </tr> <tr> <td colspan="2">N  Lo</td> <td colspan="2">CF/MAN</td> </tr> </table>	Jun 21, 2011		12:37PM		Fault	RT:	1m		FC: 0	FT:	21s		Current:FC:OP:	:	:	:	Last: FC:	:	:	:	N  Lo		CF/MAN		<p>Displays Run Time RT (min), Fault Count FC, Fault Run Time FT (sec), Current Fault(s) and Last Fault(s) when a fault condition is detected or when the pump has stopped due to a fault condition.</p>
Jun 21, 2011		12:37PM																							
Fault	RT:	1m																							
FC: 0	FT:	21s																							
Current:FC:OP:	:	:	:																						
Last: FC:	:	:	:																						
N  Lo		CF/MAN																							
<p style="text-align: center;"><b>Program Status</b></p> <table border="1" style="width: 100%;"> <tr> <td colspan="2">Jun 21, 2011</td> <td colspan="2">12:31PM</td> </tr> <tr> <td colspan="4">Program: PROG07</td> </tr> <tr> <td>Steps: 1/3</td> <td colspan="3">On interval</td> </tr> <tr> <td>Next:</td> <td colspan="3">Off interval</td> </tr> <tr> <td colspan="2">Jun 21, 2011</td> <td colspan="2">1:27:35</td> </tr> <tr> <td colspan="2">N  Hi</td> <td colspan="2">CF/PROG</td> </tr> </table>	Jun 21, 2011		12:31PM		Program: PROG07				Steps: 1/3	On interval			Next:	Off interval			Jun 21, 2011		1:27:35		N  Hi		CF/PROG		<p>Displays the status of a programmed run. Number of steps in the total program and the current and next step are shown. In the current step the progress of the step is shown.</p>
Jun 21, 2011		12:31PM																							
Program: PROG07																									
Steps: 1/3	On interval																								
Next:	Off interval																								
Jun 21, 2011		1:27:35																							
N  Hi		CF/PROG																							
<p style="text-align: center;"><b>STP</b></p> <table border="1" style="width: 100%;"> <tr> <td colspan="2">Jun 21, 2011</td> <td colspan="2">1:47PM</td> </tr> <tr> <td>Ta 25(°C)</td> <td>Pa 776mmHg</td> <td colspan="2"></td> </tr> <tr> <td>Fa 4000cc</td> <td>Va 23.264L</td> <td colspan="2"></td> </tr> <tr> <td>Ts 25(°C)</td> <td>Ps 740mmHg</td> <td colspan="2"></td> </tr> <tr> <td>Fs 4038cc</td> <td>Vs 24.384L</td> <td colspan="2"></td> </tr> <tr> <td colspan="2">N  Hi</td> <td colspan="2">CF/MAN</td> </tr> </table>	Jun 21, 2011		1:47PM		Ta 25(°C)	Pa 776mmHg			Fa 4000cc	Va 23.264L			Ts 25(°C)	Ps 740mmHg			Fs 4038cc	Vs 24.384L			N  Hi		CF/MAN		<p>In the STP model pump, this screen shows ambient temperature and pressure averages from the active or previous event and the standard values. Flow and Volume are shown at ambient and standard conditions.</p>
Jun 21, 2011		1:47PM																							
Ta 25(°C)	Pa 776mmHg																								
Fa 4000cc	Va 23.264L																								
Ts 25(°C)	Ps 740mmHg																								
Fs 4038cc	Vs 24.384L																								
N  Hi		CF/MAN																							

The LCD display can be switched between several information screens through the keypad. The pump will automatically switch to the appropriate display when certain menu items are selected or the status of the pump changes.

### 4.5.1. Display Details

1. Date and time: Displayed in selectable format mm/dd/yy or dd/mm/yy
2. Battery icon: The NiMH battery pack is identified by an "N" to the left of the icon, the AA replaceable pack is identified by an "A". When using a NiMH or AA battery pack the charge state of the battery is shown. If the pump is using a DC power pack on the Dock, "DC" is shown. Charge status is approximate and depends on many factors including age, number of charge cycles, temperature and recent charge or discharge history.
3. Flow range indicator: Displays "Hi", "Lo" or "Err" at all times. This indicator shows the setting of the flow control valve, which determines high range or low range operation of the pump. When the indicator shows "Err", the valve is between positions and must be moved to the correct detent position to operate the pump.
4. Control mode: Displays the event control mode of the pump, either constant flow (CF) or constant pressure (CPH or CPL). In constant flow mode, the pump controls the flow rate regardless of changes in the filter load (backpressure). In constant pressure, the pump controls the inlet pressure, regardless of the flow. The constant pressure modes, CPH and CPL, allow the user to select the range of expected flow for optimum control.
5. Run mode: Displays the status of the Run mode, which indicates how the pump's sampling schedule is set. There are five modes; manual, the operator turns the pump on and off; timed, the pump turns on at a preset time and off at a specified number of minutes later; Vol, the pump turns on at a specified time and collects a specified volume; RT, the pump turns on at a specified time and runs for a specified number of minutes of run time, and program, indicated by the name of the program, operating under the timing control of a user defined program which specifies on and off times and durations.

### 4.5.2. Menu Details

1. Menu items: See the Menu Outline in Appendix A for an outline of the pump menu structure.

### 4.5.3. Idle Display Details

Idle Display: The idle display is visible when the pump is turned on and whenever the pump is not in the menu or a sample event.

1. Flow set (cc/min): The flow rate, always shown in cc/min at ambient conditions.



2. Volume (L) - Sample volume: The total volume of the sample, always shown in liters, at ambient conditions.
3. Run time (min) – Sample time in minutes.
4. Datalog Events: Displays the number of events recorded, and the percentage of the storage area used.

#### 4.5.4. Constant Flow Run Display Details

1. Flow cc/min: The flow rate, always shown in cc/min at ambient conditions.
2. BP - Back Pressure: The backpressure measured at the input to the pump after the manifold and protective filter. The units of the backpressure can be selected by the operator as inches of water, millimeters of mercury, kilopascals or millibars.
3. V - Sample volume: The total volume of the sample, always shown in liters, at ambient conditions.
4. RT - Run Time: Total pump **ON** time. Does not include Sensor calibrations, pauses or scheduled off time in programs.
5. PRT - Projected Run Time: The projected run time is an estimate of the remaining run time in hours, based on the current estimated battery capacity and the current drain on the pump, which is dependent on flow rate, backpressure and temperature.

#### 4.5.5. Constant Pressure Display Details

1. BP - Back Pressure: The backpressure measured at the input to the pump after the manifold and protective filter. The units of the backpressure can be selected by the operator as inches of water, millimeters of mercury, millibars or kilopascals.
2. RT - Run Time: Total pump **ON** time. Does not include Sensor calibrations, pauses or scheduled off time in programs.
3. PRT - Projected Run Time: The projected run time is an estimate of the remaining run time in hours, based on the current estimated battery capacity and the current drain on the pump, which is dependent on flow rate, backpressure and temperature.

#### 4.5.6. Fault Display Details

1. RT - Run Time: Total pump **ON** time. Does not include Sensor calibrations, pauses or scheduled off time in programs.
2. FC - Fault Count: Total number of faults that have resulted in suspension of sampling. When the count reaches 10, the pump will cease retrying and terminate the event.
3. FT - Fault Time: Total time, in seconds, the pump has run while being in a fault status.
4. Current: Active fault display field of fault indicators, "None" is displayed unless a fault is active. The faults that may be displayed are FC (flow control out of range), PC (pressure control out of range), BP (Backpressure over allowable limit), OP (Backpressure out of allowed range, causing emergency stop), RV (recirculation valve incorrectly set for flow rate), and LB (low battery).
5. Last: Previous fault condition, same format as Current fault.

#### 4.5.7. Program Display

1. Program: Program name of selected program.
2. Steps: Number of active steps /Total number of steps Type of the active step.
3. Next: Next step function.
4. Date and time of next step start.

#### 4.5.8. STP Display

1. Ta: Average ambient temperature during active or last event
2. Pa: Average measured barometric pressure during active or last event
3. Fa: Ambient conditions flow rate
4. Va: Ambient conditions sample volume
5. Ts: Standard conditions temperature
6. Ps: Standard barometric pressure
7. Fs: Standard conditions flow rate

8. Vs: Standard conditions sample volume

#### **4.5.9. Barometric Compensation Display**

1. Pa: Ambient barometric pressure
2. Pc: Calibration barometric pressure
3. Ta: Ambient temperature
4. Tc: Calibration ambient temperature
5. Correction factor: Adjustment to flow setpoint

## 4.6. Sensor Calibration

The GilAir Plus pump has a built in automatic sensor calibration feature which allows the pump to maintain an accurate stable flow rate by intermittently calibrating the pump's flow sensor to establish the zero flow point. This routine occurs before starting, when the internal temperature of the pump changes more than 3 degrees C, or whenever one hour has elapsed since the last sensor calibration, depending on the Sensor option setting (Section 5.12.3. ). The calibration takes approximately 20 seconds during which time the pump stops running. Sample time and volume are not counted during the sensor calibration routine as the pump automatically accommodates this brief stoppage in the accumulation of sample results. The message "Sensor Calibration" displays during this process. The sensor calibrations eliminate the effect of sensor drift on flow rate stability. If the sensor calibrations are reduced or eliminated (Section 5.12.3. ) flow stability may be affected.

## 4.7. Run Mode

### 4.7.1. Run Mode Descriptions

Selecting **Run** begins a sampling event. The previous event data is cleared. Before selecting Run, the control mode, constant flow or constant pressure should have the proper setting and the flow rate or control pressure should be at the desired set point. If **Manual Run Mode** is active, the pump starts in the selected control mode at the set point. If the **Timed Run Mode** is selected, the pump waits for the start time and then starts and runs until the start time plus the specified duration. If the **Vol Run Mode** is selected, the pump waits for the start time and then starts and runs until the specified volume has been collected. If the **RT Run Mode** is selected, the pump waits for the start time and then starts and runs until the run time has elapsed; this does not count pauses, sensor calibration intervals and fault stop times. If the **Program Run Mode** is selected, the program starts and controls sampling until the program completes. When running in the high flow mode, a "Connect Media" message will pop up on the screen periodically if the pump does not see the expected backpressure caused by a sample train.

**Note: The pump is designed to operate with a minimum backpressure of 2" H<sub>2</sub>O while in the high flow mode. Operating the pump in high flow mode without any collection media attached or at a backpressure of less than 2" H<sub>2</sub>O will result in inaccurate performance.**

When the Run menu item is selected, readiness to start the event is evaluated. If the pump is using battery power, the battery status is checked. If the battery has less than about 5% of remaining charge, the event will not start. If the battery has less than 90% charge, a message box will appear to warn that the battery is not fully charged.

The recirculation valve is checked for proper position. If it is incorrectly positioned, a popup message will alert the user. If the valve is moved to the correct position, the event start evaluation will continue. If the ESC button is pressed, starting the event will be abandoned and control will return to the menu.

The Event log is checked for available space. If space is not available, a message will warn the user. If the ESC button is pressed, starting the event will be abandoned and control will return to the menu to allow the data to be recorded or downloaded before continuing. If ENTER is pressed, the pump will enter the clear datalog dialog and allow the datalog to be cleared. If the datalog is not cleared the event cannot begin. If the datalog is cleared, the event will start.





If the Event ID option is enabled, the user will be prompted to enter an Event ID, which will be stored with the event data for later review or download.

If the Pre/Post Cal option is enabled, a Pre-Cal flow calibration will start. If the ESC key is used to exit the Pre-Cal flow calibration, the event will start without adjusting the flow rate or recording a Pre Pre-Cal reading. The preset SmartCal device will be used if the pump is on the Dock, otherwise a manual calibration will be performed.

The **Stop** menu can be accessed by the  button during Run to pause or stop the event. If **Pause** is activated the pump stops with flow, timing, and total volume accurately maintained. The menu changes to allow continuation of the event. The **Stop** menu item terminates the sample event. The keypad can be locked to avoid event modification as described in the next sections.



### 4.7.2. Locking the Keypad

To lock the keypad:

Press and hold down simultaneously the  and  buttons. A lock symbol will appear in the top status line. Release the buttons and the pump will be locked. After locking the pump it will only respond using the  and  buttons to access the Idle, Fault, Program and Standard Conditions status screens. Warning: If a password is in place to restrict access to the pump, it will have to be entered to unlock the pump. Be certain that you know the password before you lock the pump.

### 4.7.3. Unlocking the Keypad

To unlock the keypad:

Press and hold down simultaneously the  and  buttons. The lock symbol will disappear from the top middle portion of the screen. Release the buttons, and the pump will be unlocked.

**IMPORTANT!** – The above instructions apply *only* if no Password (Section 5.15. ) has been selected for the pump (the Password is set at the factory default value of 0, disabled). If a Password has been previously selected, after the user has performed the instructions above, the keypad will prompt the user to enter the Password, then press and release the  button before the pump will unlock itself.

## 4.8. Flow Set (cc/min)

**Flow Set** allows the flow rate at which the pump will operate in constant flow control mode to be set. The allowable range is 20 cc/min to 5100 cc/min. Flow rates between 20 cc/min and 445 cc/min require the flow control valve to be set for low flow operation (**Lo** indicator is displayed in the bottom status line). Above 445 cc/min the flow control valve must be set for high flow operation (**Hi** indicator is displayed in the bottom status line). See the illustrations below for changing the position of the flow control valve.

### 4.8.1. Setting the Flow Rate Range

The flow rate range is set by using the hex key (provided with pump, standard 2 mm or 5/64 inch size) to change the position of the flow control valve. The following illustration shows the flow control valve in the high flow position (450 to 5100 cc/min), and the word **Hi** is indicated in the bottom status line. (See just above the users thumb).



The illustration below shows the flow range set in the low flow position (20 to 445 cc/min), as indicated by the word **Lo** at the bottom of the display screen.









The illustration below shows the flow control valve in between the **Hi** and **Lo** flow positions, where the display shows **Err**, indicating an error. The pump will not operate unless the flow control valve is in the correct **Hi** or **Lo** position for the corresponding flow rate setting.



#### 4.8.2. Setting the Flow Rate

**NOTE:** This operation is required only if you are *changing* the pump flow rate.

If you are using the previously set flow rate, you will only need to verify it using a calibrated reference flow meter.

1. At the Main Menu screen, use the  and  buttons to move the cursor ► to Flow Set.
2. Use the  and  buttons to set the desired rate of flow.
3. Press the  button to accept the flow rate. Flow set is now complete.

### 4.9. Field Calibrate

#### 4.9.1. Field Calibration

It is recommended Industrial Hygiene practice to conduct a field calibration prior to and after each field sample. This practice is commonly known as the Pre-Cal and Post-Cal. In this procedure, the sample flow rate is set and verified during the Pre-Cal using an external air flow calibrator, preferably one that is traceable to National Institute for Standards and Technology (NIST). The flow is again verified at Post-Cal using the same air flow calibration device. Procedures for field calibrations are found in the OSHA Technical Manual and in the NIOSH Manual of Analytical Methods (NMAM). Following these published guidelines for field sampling is highly recommended.



The GilAir Plus has a Pre-Cal/Post-Cal mode (See Section 5.3. ) accessible through the Set-up menu. This mode will record a Pre-Cal/Post-Cal value for each sample accessible through the PC interface and upon pump data review. Pre-Cal and Post-Cal may be conducted as separate events through the sample run mode, this method will not include calibration data as events preceding and following the sample event in the datalog.

#### 4.9.2. Calibration Option (SmartCal<sup>SM</sup>)

An optional automatic user calibration kit is available for the GilAir Plus. The automatic field calibration, known as SmartCal, provides communication between the pump and the calibrator allowing the pump to self-adjust its flow rate. Although this capability is enabled on all pump models, a communications capable Dock is required to access the SmartCal feature. A communications capable Dock is supplied as a standard accessory only with the datalog (DL) and STP models. A unique communications cable is required for each specific calibration device. When using this feature, and the Pre/Post-Cal selection, calibration data is recorded in the transferable event datalog. This option is available for the calibrators listed on the following table:

Air Flow Calibrator	Communications Cable	Cable Part Number
Gilian Gilibrator-2	Calibrator cable (Gilibrator), for automatic calibration option	780-0015-01-R
Gilian Challenger®	Calibrator cable (Challenger), for automatic calibration option	780-0015-02-R
Gilian GoCal	Calibrator cable (GoCal), for automatic calibration option	780-0015-03-R
TSI™ (Model 4146)	Calibrator cable (TSI), for automatic calibration option	780-0015-03-R
BIOS Defender™	Calibrator cable (BIOS Defender), for automatic calibration option	780-0015-04-R

Note: TSI is a trademark of TSI, Incorporated. Challenger (available through Sensidyne) is a registered trademark of BGI, Incorporated. Defender is a trademark of BIOS, Incorporated.

See Section 5.10. for **Automatic Calibration** instructions.

### 4.9.3. Displayed Flow Calibration





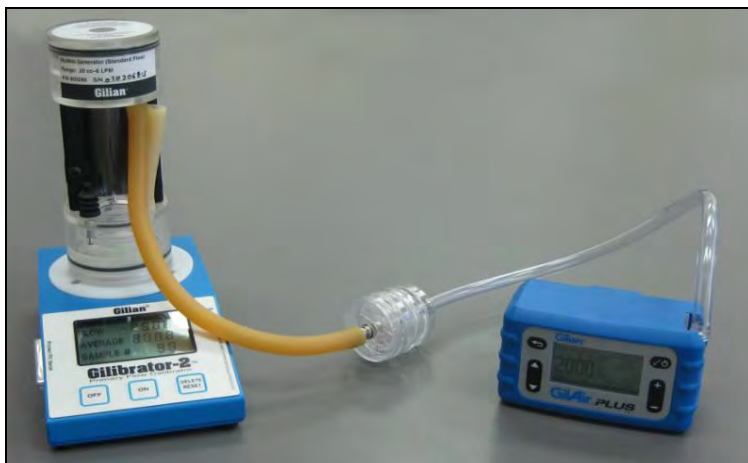



**Calibrate** allows the flow rate of the pump to be verified or adjusted to the desired operating point. The calibration will be stored and used in subsequent operation until the pump is recalibrated. Calibration is performed with an air flow calibrator and pressure panel or representative sampling media. The pressure panel should be connected to the inlet of the pump and the reference meter connected to the pressure panel inlet. Calibration always takes place at the selected flow rate.



A representative of the planned sample train should be inserted between the pump and the reference device. The ideal load is the actual sample train that will be used with a representative filter as show in the photograph below. If no load is present the flow will be more variable than with the actual sample. If the actual sample media is not available, use a load that is over two inches of water back pressure for maximum stability.



#### Calibrating the Displayed Flow Rate:

1. Set up a flow reference instrument (e.g., Gilibrator-2) following the manufacturer's instructions and recommendations.
2. Choose a sample media of similar backpressure to that intended for use in the field, or use a test panel to set the back pressure at the calibration flow rate to a representative back pressure for the sample train and flow rate. The minimum flow rate required for calibration is 2 inches of water.
3. Attach ¼ inch ID tubing from the pump to the sample media, and then from the sample media to the reference flow meter.
4. **NOTE:** To exit Calibrate without changing any values, simply press the  button.

5. Go to the Main Menu screen. Using the  and  buttons, move the cursor  to Calibrate. Press and release the  button.
6. The pump begins to run. Measure the flow rate using the reference flow meter. Use the  and  buttons to adjust the flow rate shown on the pump display to match the actual flow rate measured on the reference meter. Press and release the  button. Using the information of the actual flow rate, the pump will adjust to run at the calibration point. The displayed flow rate will return to the calibration flow rate.
7. Measure the flow rate again using the reference flow meter. If necessary, adjust the flow rate shown on the pump display to match the actual flow rate measured on the reference meter. Press and release the  button.

Repeat the adjustment until the measured flow rate is within 5% of the desired rate of flow. Calibration is now complete. Press the  button without making a change in the flow rate to exit calibration. A confirmation screen will appear. If the  is pressed the calibration will be saved. If the  is pressed the calibration will not be saved.

#### Note on User Calibration

The above display calibration procedure makes internal pump adjustments and improves the accuracy of the flow display. It does not replace field calibration as described by OSHA and NIOSH. A flow verification using the Gilibrator or other calibrator and the exact field sampling train should be conducted before and after each field sample. Procedures for field calibration may be referenced in the *NIOSH Manual of Analytical Methods* at [www.cdc.gov/niosh](http://www.cdc.gov/niosh) or in the *OSHA Technical Manual* at [www.osha.gov](http://www.osha.gov) (See Section 4.9.1. ).

## 4.10. Fault Condition Cause and Displays

When the GilAir Plus encounters operating conditions outside of the pump's operating specifications it will respond by activating the pump's fault system. The fault system will indicate a fault condition by changing the flashing green LED to a flashing red LED. After five seconds in a fault condition, the pump will display the Fault screen detailing the cause of the fault. If the fault condition persists continuously for 30 seconds, the pump will shut the sample off to prevent sample collection under fault conditions. There will be no LED illumination during the pause. If fault retry is enabled (See Section 5.8. ), the GilAir Plus will attempt an automatic re-start after three minutes. During that time if the fault cause was corrected (e.g., user sat in a chair and pinched the connection tubing shut momentarily) the pump will resume sampling. When the condition remains after ten restart attempts, the pump will end the event. If fault retry is disabled, the sampling event will end when the pump stops after 30 seconds of operation in fault and no retry will be attempted.

**Several conditions can initiate a fault condition as described below:**

**Flow Control Fault (fault code FC):** If the pump is running in the **Constant Flow Control** mode, and the flow rate cannot be maintained within the constant flow rate specification, the pump will go into a Flow Fault, a fault caused by flow outside the specifications of the pump.

**Note:** There is a user selectable option (section 5.7. ) to use the flow fault detection criteria that is specified in the EN13137 standard. If this option is selected, the criteria for fault is fully blocked flow, with fault shutdown when the duration of blockage exceeds 120 seconds. Restart will not be attempted with this option..

**Back Pressure Fault (fault code BP):** If the pump is running in the **Constant Flow Control** mode and the sample media has increased in flow resistance (i.e., backpressure) due to the accumulated sample or a blockage in the sample train, the pump will go into a fault condition after reaching its specified backpressure maximum.

**Over Pressure Fault (fault code OP):** If the pump is running in the **Constant Flow Control** mode and the backpressure exceeds the maximum allowed for the pump, an immediate fault condition and shutdown will occur. The pump will try a restart if the Fault Retry option is enabled.

**Pressure Control Fault (fault code PC):** If the pump is running in the **Constant Pressure** mode and the sample backpressure cannot be maintained within +/- 10% of the set point pressure the pump will go into a Pressure Control Fault condition. This is usually caused by insufficient sample resistance, which causes flow rates beyond the operating range of the pump.

**Low Battery Fault (fault code LB):** If the battery voltage has dropped below a minimum level, the pump will go into a fault condition due to a low battery. Restart attempts will not be made for this fault.

**Recirculation Valve Fault (fault code RV):** If the High Flow/Low Flow mode control valve is not at the correct setting, either positioned between the high and low settings or set at the incorrect setting for the flow rate selected the pump will go into a Recirculation Valve Fault. The correct High Flow/Low Flow setting must be made to resolve the fault. (Section 4.8.1. )

## SECTION FIVE: Options

---

### 5.1. Setup ►

The **Setup** submenu has controls that adjust the basic operating parameters of the pump.

To change the settings for each item in the **Setup** submenu:

1. At the Main Menu screen, use the and buttons to move the cursor ► to **Setup** ►. Press and release the button. The pump will now display the **Setup** submenu screen.
2. At the **Setup** submenu screen, use the and buttons to move the cursor ► to the submenu item for which you desire to change the setting. Use the and buttons to select the setting desired for that item, then press and release the button. The change to the new setting is now complete.

**Note:** Many setup menu items are in the submenus.

### 5.2. Event ID Enable





An event is defined as one sample run. **Event ID Enable** enables or disables the collection of sample identification information that will be stored in the event record to identify the event. When the event is enabled the pump will prompt for an ID each time an event is started. The pump will remember the event number and propose it for modification when the next event ID is required. The ID is available in **Review** and via data communications.

To utilize the **Event ID enable** function:



1. At the Main Menu screen, use the and buttons to move the cursor ► to **Setup** ►. Press and release the button. The pump will now display the **Setup** submenu screen.
2. At the **Setup** submenu screen, the cursor ► will now be at **Event enable**. The default setting for **Event enable** is **disable**. Press and release the or the to **enable**. Press and release the button.

**Note:** **Event ID** is enabled when **Run** is used to start an event. The pump will prompt the user for an ID in **Manual**, **Timed** or **Program** operation modes.





3. Press and release the button to return to the Main Menu. Use the button to move the cursor to **Run**. Press and release the button.

- Event ID 1 will now be displayed. Use the  or  buttons to assign the event any unique identification number from 1 to 999,999. The  and  keys can be used to accelerate the adjustment rate (see Section 4.4. ).

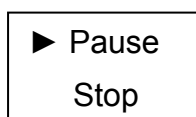
**Note:** A single press and release of either of these buttons will increment or decrement the ID number by 1. Press and hold down either button to scroll through the full range of numbers. When the ID number is selected, press and release the  button to complete.

- Upon pressing and releasing the  button, the pump will begin to run at the flow rate selected at Flow Set (see Section 4.8. ). To stop the run, press and release the  button again.
- The following message box will appear:











- Press and release the  button to move the cursor to Stop. Press and release the  button. The pump stops running.
- At the Main Menu, use the  button to go to Review. Press and release the  button. The run data for the event is displayed: Flow control mode setting; flow rate or backpressure setting; volume sampled; start time and date; Pre-Cal and Post-Cal flow rate and event ID number.

### 5.3. Pre/Post-Calibration

**Pre/Post-Calibration** allows the user to record both a Pre-Cal and Post-Cal rate of flow for a sample. The default setting for this function is **disable**. When enabled, Pre and Post-Cal flow readings will be taken in Manual, Timed and Program operating modes.

To enable the **Pre/Post-Cal** function:

- At the Main Menu screen, use the  and  buttons to move the cursor ► to **Setup** ►. Press and release the  button. The pump will now display the **Setup** submenu screen.
- At the **Setup** submenu screen, use the  and  buttons to move the cursor ► to **Pre/Post Cal**. Use the  button to select **enable** or the  button to select **disable**. Press and release the  button to complete.

This completes the enable of the Pre/Post-Cal option. The description of the use of the option when starting an event is below.



- When you are at **Run** in the Main Menu and press the button to start a sample run, the display shows a notification that Pre-Cal is selected. Press the button to continue to Pre-Cal or the to exit the event. When the Pre-Cal is entered, the calibration screen displays the set flow rate for the sample (See Section 4.8. ). Using a calibrated flow measurement reference (e.g., Gilibrator-2 or Challenger), measure the pump's flow rate, then adjust the displayed flow rate on the pump, using the and buttons, to match the flow rate displayed on the reference flow meter. Press and release the button. The pump will adjust its flow rate on the basis of the entered value to run at the setpoint flow rate. The adjustment of the displayed flow rate and correction can be repeated. To complete the Pre-Cal press enter without changing the flow rate. When complete a confirmation screen will show.

- After confirming the Pre-Cal and entering the event, the pump begins to run showing the Constant Flow display screen. Complete the sample run, then press and release the button. A **Pause/Stop** message box appears. Use the button to move the cursor to **Stop**. Press and release the button.

**Note:** When the event ends in Program or Timed operating modes, the Post-Cal will be requested at that time.

- The pump stops running and the following message appears on the screen:

### Ready for Post Cal

#### Press Enter

Press and release the button. The pump begins to run again, and the calibration screen is displayed showing the validation flow rate for the sample (See Section 4.6. ). Using the calibrated flow measurement reference, measure and enter the pump's flow rate. Press and release the button.

- To review the sample go to the Main Menu screen, use the and buttons to move the cursor to **Review**. Press and release the button. The screen shows a summary of the event data. The and buttons can be used to scroll through the data. The Pre-Cal flow rate is marked "**Pre:**". The Post-Cal flow rate is marked "**Post:**".

**Note:** SmartCal can be used to supply the Pre/Post-Cal data.

## 5.4. User Mode

Available in DL and STP models, User mode is an option that changes the operation of the menu system to only present a limited menu. Only the Run selection and a selection to exit User Mode are available. When User mode is enabled and control is returned to the idle screen, the main menu will change to offer only the User mode menu of Run and Exit. The user can start an event by selecting Run. The event can use any of the run modes available in the pump; Manual, Timed, Volume, RunTime or a program. During the event, the user can pause or stop the event, but not make any changes in its setup. The display will remain locked to the default operating display for the selected control mode (or fault if one occurs) and does not allow the user to browse the other displays.

In order to exit the User mode, the pump password is required unless the password is set to zero.

## 5.5. Power-on Run

Available in DL and STP models, Power-on Run is an option that causes the pump to start an event when the power is turned on. The event can use any of the run modes available in the pump; Manual, Timed, Volume, RunTime or a program. During the event, the user can pause or stop the event. If the run mode is Timed, Volume, RunTime or a program, the pump will power down five minutes after the event. During the period after the event, the user can change any aspect of the pump setup including the Power-on Run option. When Power-on Run is enabled, pre and post cal will not be performed.

## 5.6. Event Lock

Event Lock if enabled, sets the pump to lock the keyboard automatically when an event starts. The event will proceed as if it were locked manually after the event started. Unlock works as described above in section 4.7.3.

**Warning: IF a password has been set, it will be required to unlock the pump, just as if it were manually locked.**

## 5.7. EN13137













The GilAir Plus has two fault detection modes, normal and EN13137. When EN13137 is enabled, a flow control fault will occur when the flow rate falls to zero for more than 120 seconds as specified in the EN/ISO13137 standard. Restart will not be attempted with this option.



## 5.8. Fault Retry

When **Fault Retry** is enabled, the pump will attempt an auto restart every 3 minutes after it has encountered a condition where it has gone into fault and stopped running. The pump will attempt restart for up to 30 minutes with a total of 10 attempted restarts. The default setting for **Fault Retry** is **enabled**.

To disable **Fault Retry**, so that the pump will not attempt a restart after faulting off:

1. At the Main Menu screen, use the  and  buttons to move the cursor  to **Setup** . Press and release the  button. The pump will now display the **Setup** submenu screen.
2. At the **Setup** submenu screen, use the  and  buttons to move the cursor  to **Fault Retry**. Use the  and  buttons to select **disable** or the  button to select **enable**. Press and release the  button to complete.











## 5.9. Valve Mode

The **Valve Mode** function has 2 settings:

The **continuous** setting allows the pump to check itself continuously during a sample run to detect an incorrect setting of the flow control valve which controls the low and high flow modes of the pump. This is the default setting for the **Valve Mode** function.

The **start/stop** setting is utilized when the pump is used in an environment where it might be exposed to extreme magnetic interference. When **Valve Mode** is in **start/stop**, the pump will only check the positioning of the flow control valve at the beginning and end of a sample run to minimize any adverse effect from magnetic interference.

To put the **Valve Mode** into **start/stop**:

1. At the Main Menu screen, use the  and  buttons to move the cursor  to **Setup** . Press and release the  button. The pump will now display the **Setup** submenu screen.
2. At the **Setup** submenu screen, use the  and  buttons to move the cursor  to **Valve Mode**. Use the  and  buttons to select **start/stop** or **continuous**. Press and release the  button to complete.

## 5.10. SmartCal<sup>SM</sup> Automatic Calibration

GilAir Plus has an optional automatic calibration capability called SmartCal. Select an air flow calibrator and connect it to the Dock using the appropriate communications cable. When active; Pre, Post and flow calibration can be performed automatically through the Dock. This option requires the communications version of the Dock, (standard with DL and STP models). (See Section 4.9.2. for a list of calibration devices



and communications cables). If a multiposition Dock is used (3 or 5 station) the pump must be on the rearmost position where the power and calibrator attach. The Dock must be connected to the calibrator using the specific cable for that calibration device.

The tubing setup is the same as a manual calibration (See Section 4.9.3. ). Using the SmartCal feature requires the GilAir Plus pump to be connected to the Dock with the cable to the calibrator plugged in.

The calibrator type must be specified to the pump before use. The calibrator type can be selected in the **Setup** ► SmartCal menu item. After specification, the calibrator type is stored and used whenever the pump is calibrated on a Dock. If calibration is performed when the pump is not Docked, the manual calibration option will be used.

When **Calibrate** is selected from the main menu, the pump enters SmartCal and displays the type of calibrator and the current flow rate reading. Follow the instructions for your calibrator to begin the calibration.

### 5.10.1. Gilibrator-2

Once the flow rate stabilizes, generate a series of bubbles. After each bubble, the pump will adjust flow to a new rate closer to the calibration value. After several bubbles the flow rate will be within 1% of the setpoint. Continue to generate bubbles and when enough bubbles have been seen to establish stability, the pump will complete the calibration. If a bad bubble occurs, continue generating bubbles and the pump will tolerate the error and adjust correctly. If bad bubbles occur repeatedly, terminate the calibration with the  button and fix the Gilibrator. When the GilAir Plus determines stability the calibration will be calculated and stored. *Calibration Complete* will be displayed. The  button can be used to return to the main menu.



1. Connect the SmartCal cable to the PC Serial connector on the Gilibrator and the Reference Device port on the rear of the Dock.
2. Using the GilAir Plus pump main menu, go to **Setup ▶ SmartCal**. Use the **+** and **-** buttons to select **Gilibrator**. Press and release the **✓⏻** button. This step need not be repeated if already set. Go to **Flow set**. Use the **+** and **-** buttons to set the flow rate. Press and release the **✓⏻** button. Go to **Calibrate**, then press and release the **✓⏻** button. The pump will begin to run in the SmartCal mode.
3. While running in the SmartCal mode before readings are taken on the Gilibrator the following is displayed:
 

**SmartCal**  
**Gilibrator 0 cc/m**
4. Take readings on the Gilibrator. After each reading, the flow will change and after several bubbles will be at the setpoint. Refer to the Gilibrator user manual to locate instructions for taking a reading.
5. After the flow rate is within 1% of the setpoint additional bubbles are processed to evaluate the stability of operation. When the stability criterion is met the calibration is complete. *Calibration Complete* is displayed and the pump stops. Confirm with the **✓⏻** button to save the calibration. If desired the calibration can be aborted with the **↩** button.
6. **Before removing the pump from the Dock**, press and release the **↩** button. The Main Menu screen is displayed. Remove the pump from Dock. If desired, go to **Run**. Press and release the **✓⏻** button. The pump begins to run at the selected flow rate.

### 5.10.2. Challenger®



Verify the desired calibration flow rate is within the Challenger range. Select the appropriate range if necessary. The Challenger reads flow continuously and reports it for display on the GilAir Plus. When flow stability is reached, the calibration will be calculated and stored in the pump. *Calibration Complete* will be displayed. The button can be used to return to the main menu.



1. Connect the SmartCal cable between the RS232 port on the Challenger and the Reference Device connector on the rear of the Dock.
2. Check that the Challenger is set to the range required for the calibration measurement. Power on the Challenger before connecting the Challenger to the Dock via the cable, and leave the Challenger undisturbed as it self-calibrates. When “Qa” and “Qs” values are displayed on the Challenger connect the hose from the GilAir Plus air sampler to the Challenger and connect the SmartCal cable to the Challenger and Dock.
3. On the GilAir Plus pump, go to **Setup**, then **SmartCal**. Use the and buttons to select **Challenger**. Press and release the button. This setup is only required once. Go to **Flow set**. Use the and buttons to set the desired flow rate. Press and release the button. Go to **Calibrate**, then press and release the button. The pump will begin to run in the SmartCal mode.
4. While running in the SmartCal mode, the Challenger continuously displays the flow rate, and the following is displayed on the pump:

**SmartCal**  
**Challenger (flow rate) cc/m**





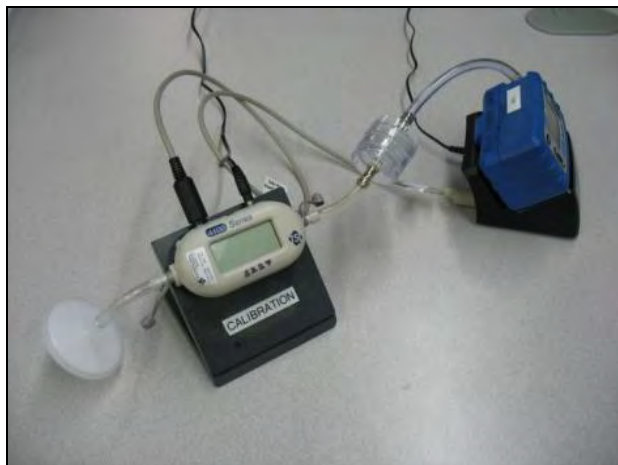

5. The GilAir Plus will run for a few minutes adjusting its flow rate to the calibration value using the readings from the Challenger. *Calibration Complete* will be displayed and the pump will stop.

6. **Before removing the pump from the Dock**, press and release the  button. Remove the pump from the Dock and disconnect the cable from the Challenger then go to **Run** in the Main Menu, and press and release the  button.
7. The pump begins to run at the set flow rate.



### 5.10.3. TSI™ Model 4146 and Sensidyne Go-Cal

The TSI Model 4140/Sensidyne Go-Cal reads flow continuously and reports it for display on the GilAir Plus. When flow stability is reached, the calibration will be calculated and stored. *Calibration Complete* will be displayed. The  button can be used to return to the main menu. The SmartCal sets the operating mode of the calibrator to the setup required for proper calibration. After completion of the calibration, the calibrator is returned to the standard setup for the Go-Cal.



1. Connect the SmartCal cable between the interface port on the TSI Model 4140 and the Reference Device port on the rear of the Dock.
2. On the GilAir Plus pump, go to **Setup**, then SmartCal. Use the  and  buttons to select **TSI**. Press and release the  button. This setup is only required once. Go to **Flow set**. Use the  and  buttons to set the desired flow rate. Press and release the  button. Go to **Calibrate**, then press and release the  button. The pump will begin to run in the SmartCal mode.
3. While running in the SmartCal mode, the TSI 4140 displays the flow rate, and the following is displayed on the pump:  
**SmartCal**  
**TSI (flow rate) cc/m**
4. When flow stability is reached, the calibration will be calculated and stored. *Calibration Complete* will be displayed.









5. **Before removing the pump from the Dock**, press and release the  button. The Main Menu screen is displayed. Remove the pump from Dock. Go to **Run**. Press and release the  button. The pump begins to run at the set flow rate.

#### 5.10.4. Bios Defender™ 510, 520, 530

The Defender has a limited flow range, verify that the desired calibration flow rate is within range. The Defender is set to cycle continuously and read flow. When adequate samples are collected to guarantee flow stability, the calibration will be calculated and stored. *Calibration complete* will be displayed. The  button can be used to return to the main menu.



1. Setup the GilAir Plus and Bios Defender with the SmartCal cable connected to the Data port on the Defender and the Reference Device connector on the rear of the Dock as shown in the photo.



2. Set up the BIOS Defender to sample continuously. On the GilAir Plus pump, go to **Setup**, then **SmartCal**. Use the  and  buttons to select **BIOS Dfndr**. Press and release the  button. This setup is only required once. Go to **Flow set**. Use the  and  buttons to set the desired flow rate. Press and release the  button. Go to **Calibrate**, then press and release the  button. The pump will begin to run in the SmartCal mode.
3. While running in the SmartCal mode, the BIOS Defender displays the flow rate for each sample taken, and the following is displayed on the pump:

**SmartCal**  
**BIOS Dfndr (flow rate) cc/m**

4. When adequate samples are collected to guarantee flow stability, the calibration will be calculated and stored. *Calibration complete* will be displayed.







5. **Before removing the pump from the Dock**, press and release the  button. Then remove the pump from the Dock, go to **Run** in the Main Menu, and press and release the  button. The pump begins to run at the set flow rate.

### 5.11. Clear Datalog

**Clear Datalog** erases all datalog entries. When the datalog is full, any data saved in subsequent events will be lost. The datalog should be cleared after the data is extracted to allow space for new events. **The Datalog has the capacity to store up to 16 events.** The number of slots consumed in the datalog is shown on the Idle screen. Starting an event without space in the datalog will cause a warning screen and the datalog must be cleared to before initiating an event is possible. Transfer any required data to written records or use the PC app to transfer to the computer database.

To clear the datalog:

**IMPORTANT! Verify that all desired data has been archived prior to clearing!**

1. At the Main Menu screen, use the  and  buttons to move the cursor ► to **Setup** ►. Press and release the  button. The pump will now display the **Setup** submenu screen.
2. At the **Setup** submenu screen, use the  and  buttons to move the cursor ► to **Clear Datalog**. Press and release the  button. The following message box will be displayed:

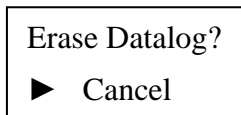

**Note:** To cancel out of **Clear Datalog**, press and release the  button at this time.

3. Press and release the  or  button. The message box now displays:

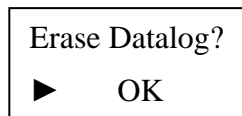

4. Press and release the  button. The Datalog is now erased.











## 5.12. Run Options ►

### 5.12.1. Standard Temperature (STP Models only)

Users may set the temperature that will be used in the calculation of the standard flow and volumes when using a STP Model pump. The GilAir Plus factory default is 25°C (77°F) as the standard temperature.

**To set the Standard Temperature:**







1. At the Main Menu screen, use the  and  buttons to move the cursor ► to **Setup** ►. Press and release the  button. The pump will now display the **Setup** submenu screen.
2. At the **Setup** submenu screen, use the  and  buttons to move the cursor ► to **Run Options** ►. Press and release the  button.
3. The cursor ► will now be at **Std Temp (° C or °F)**. The current setting for **Std Temp (° C or °F)** will be displayed at the right side of the screen. Use the  and  buttons to adjust the setting to the temperature desired.





**Note:** A single press and release of either of these buttons will increment or decrement the temperature setting by 1 degree. Press and *hold down* either button to scroll through the full range of numbers. When the desired temperature setting is selected, press and release the  button to complete.

### 5.12.2. Standard Pressure (mmHg) (STP models only)

Users may set the pressure that will be used in the calculation of the standard flow and volumes when using a STP model pump. The GilAir Plus factory default is 760 mmHg as the standard pressure.

**To set the Standard Pressure:**

1. At the Main Menu screen, use the  and  buttons to move the cursor ► to **Setup** ►. Press and release the  button. The pump will now display the **Setup** submenu screen.
2. At the **Setup** submenu screen, use the  and  buttons to move the cursor ► to **Run Options** ►. Press and release the  button.

- The cursor ► will now be at **Std Temp (° C)**. Press and release the  button to move the cursor ► to **Std P (mmHg)**. The current setting for **Std P (mmHg)** will be displayed at the right side of the screen. Use the  and  buttons to adjust the setting to the pressure desired. **Note:** A single press and release of either of these buttons will increment or decrement the pressure setting by 1. Press and *hold down* either button to scroll through the full range of numbers. When the desired pressure setting is selected, press and release the  button to complete.

**Note:** mmHg is the only pressure unit used for standard pressure.

### 5.12.3. Sensor Option

This option controls sensor calibration during sampling events. The sensor calibration is done at the beginning of each event to zero reference the flow measurement. During the event it is normally done at one hour intervals and whenever the temperature change at the flow sensor changes by more than 3 degrees C. The Sensor Option control has three settings, All, Hourly, and None. The operation in each option selection is described below.

All: All sensor calibrations are enabled, hourly and on temperature change.

Hourly: Only hourly sensor calibrations are enabled, not on temperature change.

None: No sensor calibrations are done during the event.

**Note:** The sensor calibration eliminates the major source of drift in the flow control system and ensures that drift will not affect flow accuracy. If sensor calibrations are reduced or eliminated, long term flow stability may be affected.

### 5.12.4. PaTa compensation (STP models only, in high flow)

This option enables a compensation to be applied for changes in ambient conditions. The correction adjusts the flow control to compensate for the change in barometric pressure and ambient temperature since the last calibration. This allows calibration at set of ambient conditions and operation across a wide range of pressure and temperature. The compensation barometric pressure and temperature ranges are given in Appendix C .

To use this feature, it must first be enabled. When enabled, a warning will be displayed after a change in flow rate that the pump must be calibrated at the flow rate. After calibration, the flow rate will be compensated.









## 5.13. Display Options ►

These parameters control the appearance and format of displayed pump data.

### 5.13.1. Language

Users may select the display language; languages available include: English, Spanish, French, Dutch, German, Italian, Portuguese and Turkish. English is the default.











To select the display language:

1. At the Main Menu screen, use the  and  buttons to move the cursor ► to **Setup** ►. Press and release the  button. The pump will now display the **Setup** submenu screen.
2. At the **Setup** submenu screen, use the  and  buttons to move the cursor ► to **Display Options** ►. Press and release the  button.
3. The cursor ► will now be at **Language**. Press and release either the  or  button. Each press and release allows you to select from the following choices of languages: English, Spanish, French, Dutch, German, Italian, Portuguese and Turkish. When the desired language is selected, press and release the  button to complete.

### 5.13.2. Temperature Units

Set the displayed temperature unit to **Celsius** or **Fahrenheit**.











To set the units in which temperature is displayed:

1. From the Main Menu screen, use the  and  buttons to move the cursor ► to **Setup** ►. Press and release the  button. The pump will now display the **Setup** submenu screen.
2. At the **Setup** submenu screen, use the  and  buttons to move the cursor ► to **Display Options** ►. Press and release the  button.
3. Press and release the  button to move the cursor ► to **Temperature Units**. Press and release either the  or  button. Each press and release allows you to select either °C or °F. When the desired unit is selected, press and release the  button to complete.

### 5.13.3. Pressure Units

Set the displayed unit of pressure for backpressure to **"H<sub>2</sub>O, mmHg, KPa or millibar**.

To set the units in which pressure is displayed:













1. At the Main Menu screen, use the  and  buttons to move the cursor ► to **Setup** ►. Press and release the  button. The pump will now display the **Setup** submenu screen.
2. At the **Setup** submenu screen, use the  and  buttons to move the cursor ► to **Display Options** ►. Press and release the  button.
3. Press and release the  button to move the cursor ► to **Pressure Units**. Press and release either the  or  button. Each press and release allows you to select **"H<sub>2</sub>O, mmHg, KPa or millibar**. When the desired unit is selected, press and release the  button to complete. In display screens, inches of water is abbreviated " , mmHg is abbreviated Hg, KPa is abbreviated KP, and millibar is abbreviated mbar.

### 5.14. Clock Set ►

Set the date, time, and hour format.

















#### 5.14.1. Clock

To set the time of day:

1. At the Main Menu screen, use the  and  buttons to move the cursor ► to **Setup** ►. Press and release the  button. The pump will now display the **Setup** submenu screen.
2. At the **Setup** submenu screen, use the  and  buttons to move the cursor ► to **Clock Set** ►. Press and release the  button.
3. The cursor ► will now be at **Clock**. Use the  and  buttons to set the hour. When the desired hour is selected, press and release the  button to confirm and continue to the next step to edit the minutes.
4. Following the same steps use the  and  buttons to set the minutes. When the desired value for minutes is selected, press and release the  button to confirm. The selected time will be displayed at the top right portion of the display screen.

### 5.14.2. Date











To set the Date:

1. At the Main Menu screen, use the  and  buttons to move the cursor ► to **Setup** ►. Press and release the  button. The pump will now display the **Setup** submenu screen. At the **Setup** submenu screen, use the  and  buttons to move the cursor ► to **Clock Set** ►. Press and release the  button.
2. Press and release the  button to move the cursor ► to **Date**. Use the  and  buttons to set the year. When the desired year is selected, press and release the  button to confirm and continue to the next step to set the month.
3. Following the same steps the month can be set with the  and  buttons. When the month is selected press the  button to confirm and continue to the next step to set the day.
4. Following the same steps the day can be set. Use the  and  buttons to select the day. When the day is selected, press and release the  button to confirm. The selected month, day and year will be displayed in the top left portion of the screen.

### 5.14.3. Time Format

Choose between 12-hour and 24-hour clock display.











To select the displayed **Time Format**:

1. At the Main Menu screen, use the  and  buttons to move the cursor ► to **Setup** ►. Press and release the  button. The pump will now display the **Setup** submenu screen.
2. At the **Setup** submenu screen, use the  and  buttons to move the cursor ► to **Clock Set** ►. Press and release the  button.
3. Press and release the  button to move the cursor ► to **Time format**. Use the  and  buttons to select either the **12h** or the **24h** format. When the desired time format is selected, press and release the  button to complete. The time will now be displayed in the selected format in the top status line.

#### 5.14.4. Date Format

Select between MM/DD/YY and DD/MM/YY date formats.

**To set the Date Format:**









1. At the Main Menu screen, use the  and  buttons to move the cursor ► to **Setup** ►. Press and release the  button. The pump will now display the **Setup** submenu screen.
2. At the **Setup** submenu screen, use the  and  buttons to move the cursor ► to **Clock Set** ►. Press and release the  button.
3. Press and release the  button to move the cursor ► to **Date format**. Use the  and  buttons to select either the **mm/dd/yy** or the **dd/mm/yy** format. When the desired date format is selected, press and release the  button to complete. The date will now be displayed in the selected format in the top left portion of the screen.

#### 5.15. Password

The GilAir Plus offers a password protection feature. The password for unlocking the keypad can be set in this menu item. A password may consist of 1-4 numerals. If the password is set to 0, the password will not be required and the keypad will unlock without password entry.

Change password to 0 to remove password.

**To set the password:**

1. At the Main Menu screen, use the  and  buttons to move the cursor ► to **Setup** ►. Press and release the  button. The pump will now display the **Setup** submenu screen.
2. At the **Setup** submenu screen, use the  and  buttons to move the cursor ► to **Password**. Use the  and  buttons to assign any unique number from 0 to 9999 as a password. Press and *hold down* either button to scroll through the full range of numbers. When the *password* is selected, press and release the  button to complete.

## 5.16. Control Mode

### CF (Constant Flow), CPH (Constant Pressure High), CPL (Constant Pressure Low)

The **Control Mode** determines which control parameter the GilAir Plus holds constant during the sample. The two control mode options are holding the flow constant or holding the pressure constant. Both control modes will operate in high flow and low flow. High flow is 450 cc/min and higher, low flow is less than 450 cc/min. Minimum flow in **Constant Flow** is 20cc/min. **Constant Flow** control should be chosen for single samples, and **Constant Pressure** control should be chosen when splitting the flow into multiple samples. In the **Constant Flow** mode, both the flow rate and the backpressure are displayed. In the **Constant Pressure** mode only the backpressure is displayed. Constant pressure control requires sample media holders with needle valves to control the flow rate. In the constant pressure mode, the flow rate is read at the external calibrator only.

**Constant Flow Control** and **Constant Pressure Control** are fundamentally different modes of operation. A description of the two modes follows.

**Constant Flow Control** holds the flow rate constant throughout the sample duration, even in the presence of variations in the backpressure of the sample media often caused by backpressure buildup on the filter.

**Constant Pressure Control** maintains a constant pressure level at the inlet of the pump, which provides a stable vacuum for drawing the sample. A needle valve is required in the sample media holder to set the flow rate. If the sample media resistance is constant, the flow through the media will also remain constant.

This mode allows the sample to be split, and it is also called the **Multi-Flow Mode**. This mode requires a sample media holder that incorporates a needle valve in each split segment.



*Example; a dual holder will require two needle valves to set the two flow rates independently. The constant pressure source allows the flow to be split, because adjusting one side does not change the flow rate through the other side, since the collective force pulling the two samples remains constant.*

Constant pressure mode maintains constant flow in the sample only when the flow resistance of the sample path remains constant during sampling. If the flow resistance varies the flow rate will vary. With the default pressure set point of 18 inches of water, if the pressure varies by 0.9 inches of water, the flow will change by about 5%. Care should be used in selecting the applications that are used with constant pressure control and the behavior of the sample resistance under field conditions should be verified.

To select the **Control Mode**:

1. At the Main Menu screen, use the  and  buttons to move the cursor  to **Control Mode**. Press and release the  button.



2. Use the  and  buttons to select either the **CF** (Constant Flow [20-5100 cc/min]), **CPL** (Constant Pressure Low [1-449 cc/min]) or the **CPH** (Constant Pressure High [450-5100 cc/min]) control mode. When the desired control mode is selected, press and release the  button to complete. The selected control mode will now be displayed in the bottom status line.

**Note:** The flow control valve must be set to the **Lo** position for running less than 450 cc/min and it must be set in the **Hi** position for running 450 cc/min and for both the constant flow and constant pressure control modes.

### 5.17. Run Mode: Manual, Timed, Vol, RT and Program name

The **Run Mode** selection determines how the timing of the event is managed. In **Manual** mode, the pump is switched on and off with the keypad. Any run time is possible within the limits of the pump capacity. In **Timed** mode, the start time and stop time of a sample is specified in the **Run Setup** submenu. The **Vol, RT** and **Program** modes are offered only in the Datalog and STP models. The **Timed** mode is a feature of all three models.







The following additional modes are available in DL and STP models:

In **Vol** mode the start time and total volume sampled is specified in the **Run Setup** submenu. The specified volume (in Liters) will be taken. In **Vol** mode the control mode must be in Constant Flow (CF) to allow measurement of the specified volume. If an event has a Constant Pressure (CPL or CPH) mode specified an error will be shown when the event is run.

In **RT** mode the start time and the event sampling duration is specified in the **Run Setup** submenu. The duration is independent of pauses, sensor calibrations, and fault off time.

In **Program** mode, the flow rate and a series of clock times, dates, days of the week, on-periods and off-periods can be programmed. The program is entered in **Program edit** under **Run Setup**. Each Program has a name and the names are shown in this menu item selection to allow the desired run parameters to be set.

#### To set the Run Mode:

1. At the Main Menu screen, use the  and  buttons to move the cursor ► to **Run Mode**. Press and release the  button.
2. Use the  and  buttons to select either the desired mode. When the desired run mode is selected, press and release the  button to complete.



**Note:** User programs will be listed as available **Run Mode** selections *in addition to the Manual, Timed, Vol and RT modes*, these can be selected the same way.

**Note:** When the pump is powered on it will remember the last set **Run Mode, Manual, Timed, Vol, RT** or selected Program. If a different mode is desired, it must be set before running an event.

## 5.18. Run Setup ►









Go to **Run Setup** to set the parameters for constant pressure mode operation, timed and programmed runs.

**To enter Run Setup:**

At the Main Menu screen, use the  and  buttons to move the cursor ► to **Run Setup** ►. Press and release the  button.

### 5.18.1. Timed Start (T/V/R start)

Select a specific clock time as the beginning time of a sample event. At the selected time, the pump will sample for the timed duration as specified below. The event will start when the time is after the set time. If the timed Start is set to midnight (00:00:00) the event will start immediately and use the current time as the start time.

1. At the Main Menu screen, use the  and  buttons to move the cursor ► to **Run Setup** ►. Press and release the  button.
2. The cursor ► will now be at **T/V/R start**. On the display screen, to the right of **Timed start**, a clock time is displayed in the selected system time format. Use the  and  buttons to set the hour. When the hour is selected, press and release the  button.
3. The minute portion of the clock time can now be adjusted. Use the  and  buttons to set the minutes. When the minutes are selected, press and release the  button. The setting of the start time for the timed run is now complete.

## 5.19. Timed Duration

**Timed Duration** specifies the how many minutes after the time specified in **T/V/R start** the event will end. The event starts as soon as the time has passed. If the T/V/R start time is set to 0:00 it will start immediately and use the current time as the start time. The event will end at the start time plus the specified duration. As an example, if the start time is 1:00, and the duration is 120min, the event will start at 1:00 am and conclude at 3:00am. If the event is started after 1:00am it will start immediately and run until 3:00am. If started after 3:00am it will start the pump and end the event immediately since both 1:00am and 3:00am have passed. The pump will run for less than one second.

### To set:

1. At the Main Menu screen, use the and buttons to move the cursor ► to Run Setup ►. Press and release the button.
2. Use the and buttons to move the cursor ► to Timed Duration. Use the and buttons to set the time for the duration of the run in minutes. When the run time in minutes is selected, press and release the button. The setting of the stop time for the event is now complete.

## 5.20. Vol Set

**Vol Set** allows the specification of the volume to be collected in the event. The volume is in liters.

### To set:





1. At the Main Menu screen, use the and buttons to move the cursor ► to Run Setup ►. Press and release the button.
2. Use the and buttons to move the cursor ► to Vol Set. Use the and buttons to set the number of liters to collect. When the volume is selected, press and release the button. The setting of the volume for the event is now complete.

## 5.21. RT

**RT** specifies the how many minutes the event will run, sensor calibration, user pauses and shutdown times due to fault will not be included.

### To set:

1. At the Main Menu screen, use the and buttons to move the cursor ► to Run Setup ►. Press and release the button.

2. Use the  and  buttons to move the cursor ► to RT. Use the  and  buttons to set the time for the duration of the run in minutes. When the run time in minutes is selected, press and release the  button. The setting of the run time for the event is now complete.









**Note:** See Section 6.1. and Appendix B for advanced programming the DL and STP models.

## 5.22. Pressure Set ("H<sub>2</sub>O, mmHg, KPa or mbar)

**Pressure set** is used to set the pressure that will be maintained when the pump is running in the constant pressure (**CPL or CPH**) control mode (See Section 5.16. ). Available pressure set points are between 5 inches of water to 30 inches of water. If the pressure is set outside the performance capability of the pump, a fault will occur when **Run** is selected.

**Note:** Factory default is 18 inches of water.

To set the pressure that will be maintained in the Constant Pressure Mode:

1. At the Main Menu screen, use the  and  buttons to move the cursor ► to **Run Setup** ►. Press and release the  button.
2. Use the  and  buttons to move the cursor ► to **Press set ("H<sub>2</sub>O, mmHg or KPa)** (See Section 5.13.3. to select units). Use the  and  buttons to set the pressure. When the pressure is selected, press and release the  button to complete.

**SECTION SIX: Programming**

**6.1. Program ►**

User programs specify a series of actions that control the sampling protocol employed by the pump. The pump can store up to 16 programs, each of which can be created, edited and executed. A program allows the specification of flow rate, control mode and the timed steps that determine when the pump runs.

**Note:** This advanced level of programming is available only in the Datalog and STP models.

**IMPORTANT! – FOR AN ENTERED PROGRAM TO BE ABLE TO RUN:**  
 The entered program will be one of sixteen allowed and will be named as selected in the entry edit procedure (Section 6.3. ), and it must be saved (Section 6.9. ). Run Mode must be set to that program name (Section 5.17. ).

*Note: An example detailing the procedures for entering and editing a program can be found in Appendix B.*

**Note:** Users can create, edit and load programs in the PC Application.

Programs specify a series of clock determined operations. Operations can wait for a specified time of day, turn on for a specified time, turn off for a specified time and cycle back to the previous steps a specified number of times. Clock determined means that the program sets a series of times that are used for all steps and pump on times or pump off times. An example will make it clear.

Program Step	Function	Value	Starts at	Ends At	Pump Action
1	Time	8:00 AM	Run Start	8:00 AM	Off
2	On	240	8:00 AM	12:00 PM	On
3	Off	60	12:00 PM	1:00 PM	Off
4	On	240	1:00 PM	5:00 PM	On
5	End	0	5:00 PM	5:00 PM	Off

User selected or pump controlled off times will adjust the sampling time, but will not change the beginning or ending times. Pump controlled off times include Sensor Calibrations and fault pauses. User controlled off times are keypad initiated pauses. When the RT or VOL program steps are used, the timing is set by the sampling time, not counting sensor calibrations, fault caused pauses or user pauses.

For example, in an ON step, if the user pauses the pump at 9:00 for 30 minutes, the total run time will be 450 minutes instead of 480, and the program step changes will occur at the scheduled times. Pausing the pump will not alter the next step begin time.

In a RT step, if the user pauses the pump for 30 minutes, the step will extend the end time so that the actual run time is as specified in the step. Similarly, the VOL step determines the end of the step by the actual volume sampled, not by the time.







Programming sample schedules can be complicated when more advanced scheduling steps are involved. Some examples are shown in Appendix B that will assist in advanced programming.

## 6.2. Program Edit ►

This submenu allows the creation and editing of up to 16 programs. Each program is stored in nonvolatile flash memory and can be selected using the **Run mode** item on the main menu (See Section 5.17. ).

**IMPORTANT!** Programs that are created or modified must be saved for the changes to be retained. If the program is not saved before exiting **Entry/Edit** it will be lost. If a change is made to a program, the "Save" menu item will show "Changed" indicating that a change has been made and editing is abandoned, the changes will be lost.

To navigate to the **Program Edit** function:



1. At the Main Menu screen, use the  and  buttons to move the cursor ► to **Run Setup** ►. Press and release the  button.
2. Use the  and  buttons to move the cursor ► to **Program Edit** ►. Press and release the  button.

### 6.3. Program Name

The program name is displayed when the **Run mode** is selected after a program has been entered and saved. When the program is entered on the pump, a name is assigned, i.e. – **PROG01** through **PROG16**.

**Note:** Using the *data communication option and a PC*, alphanumeric program names may also be assigned.

To pick a program to enter/edit:







1. While in the **Program Edit** menu (section 6.2. ).
2. Move the cursor to **Prog Name**. At the right of **Prog Name**, a program name such as **PROG01** is displayed. Use the  and  buttons to select the **desired program**, then press and release the  button to complete.

### 6.4. Control Mode

Use to select either the **Constant Flow** or **Constant Pressure** control mode for a program. The **Set point** function is used to set the flow rate or pressure depending on the setting of this parameter. The **Constant Pressure Mode** must specify either High flow mode (CPH) or Low Flow mode (CPL).

If the CF mode is not set for a program that includes a VOL program step, an error will be shown when the program is started.







To select the **Control Mode** for a program:

1. While in the **Program Edit** menu (section 6.2. ).
2. Use the  and  buttons to move the cursor  to **Control Mode**. Use the  and  buttons to select the control mode in which you want the pump to run during the execution of the program, then press and release the  button to complete.

### 6.5. Set the Flow Rate or Pressure

The flow rate set point for constant flow is selected in the **Program Edit** submenu. The same limits and restrictions apply in **Program Mode** as in **Manual Mode**.

To program the **Setpoint** flow rate for a program:





1. While in the **Program Edit** menu (section 6.2. ).
2. Use the  and  buttons to move the cursor  to **Setpoint**. Use the  and  buttons to select the set point flow rate or pressure at which you want the pump to run during the execution of the program, then press and release the  button to complete.



## 6.6. Program Steps

Each program step is numbered and executed sequentially. To enter or edit a program select the desired program step and edit it to perform the desired function. A program may have up to 20 steps.

To enter or edit a particular program step:

1. While in the **Program Edit** menu (section 6.2. ).
2. Use the  and  buttons to move the cursor  to **Prog Step**. Use the  and  buttons to select the program step you wish to enter or edit.

## 6.7. Function

Each program step performs a specific function. The available functions are:

- **On Interval** - turns on the pump for the specified number of minutes.
- **Off Interval** - specifies a time during which the pump does not sample.
- **Cycle** - loops back and repeats for a specified number of times to the last cycle function or the beginning of the program if there is no previous cycle function. It can be used to specify the destination of a of a cycle command later in the program (Cycle 0).
- **Time** - waits for a specified time to arrive before the next program step is executed. The time base setting for the next step is set to the time in the command.
- **Date** - waits for the date specified in the value. The time base setting for the next step is set.
- **Weekday** - waits for the day of the week specified in the value. The time base setting for the next step is set.
- **Vol** - will run the pump and collect the specified volume (in liters). The program must use CF control mode for this step type.
- **RT** - turns on the pump to run for the specified number of minutes, not counting sensor calibrations, user pauses and fault shutdown time.
- **End** - terminates the program.

The cycle function is used mainly for intermittent sampling (e.g., 5 minutes on and 55 minutes off for 72 hours).

**IMPORTANT! – Verify that you are at the correct program step (and change it if necessary per Section 6.6. ) before selecting or changing the function to be performed at that program step.**

To set the **Function** for a particular program step:

1. While in the **Program Edit** menu (section 6.2. ).
2. Use the and buttons to move the cursor ► to **Function**. Use the and buttons to select the program function you want the pump to perform at a particular program step, then press and release the button to complete.













## 6.8. Function Value

Specifies the parameter associated with the function selected to be performed at a particular program step. For **Time**, the parameter is a time of day; for **On Interval** and **Off Interval**, the parameter is time in minutes; for **Cycle**, the parameter is number of cycles, for **Date** the parameter is a date and for **Weekday**, the parameter is a day of the week, for **Vol** the parameter is a Volume in Liters, for **RT** the parameter is in minutes.

**IMPORTANT!** – Verify that you are at the correct program step (and change it if necessary per Section 6.6. ) and that the correct program function (Section 6.7. ) has been entered for that step before selecting or changing the function value to be performed at that program step.

To set the **Value**:

1. While in the **Program Edit** menu (section 6.2. ).
2. After verifying that you have entered the correct program step (Section 6.6. ) and the correct program function (Section 6.7. ) that you wish to enter or change the function value, use the and buttons to move the cursor ► to **Value**. If the program step you are entering/changing has the **Time** function assigned, then use the and buttons to select first the hour (in 24-hour format), press and release the button, then use the and buttons to select the minute, then press and release the button to complete.
3. If the program step you are entering/changing has the **On Interval** or **Off Interval** function assigned, use the and buttons to select the number of minutes for the duration of that interval, then press and release the button to complete.
4. If the program step you are entering/changing has the **Cycle** function assigned, use the and buttons to specify the total number of cycles for the number of times you want the pump to loop back and repeat the entire program, then press and release the button to complete.



5. If the program step you are entering/changing has the **Date** function assigned, use the  ,  and  buttons to set the date to the desired day.
6. If the program step you are entering/changing has the **Weekday** function assigned, use the  and  buttons to specify the desired day of the week. Press the  button to complete.
7. If the program step you are entering/changing has the **Vol** function assigned, use the  and  buttons to specify the desired volume. Press the  button to complete.
8. If the program step you are entering/changing has the **RT** function assigned, use the  and  buttons to specify the minutes of runtime desired. Press the  button to complete.

### 6.9. Save a Program



**Save** is used to store the edited program to the nonvolatile memory. If the program has been changed, the word "Changed" will be shown at the "Save" menu item.

**IMPORTANT! All changes will be lost unless the program is saved! The program will remind to save if a change has been made and exit is attempted.**

To **Save** a program after it has been entered or edited:









Use the  and  buttons to move the cursor ► to **Save**. To the right of **Save**, you will see the message **Changed** displayed. Press and release the  button. The **Changed** message disappears from the screen. The program has now been saved to non volatile memory.

### 6.10. Review Events

**Review** allows the pump to display the results of the last 16 sample events. When the item is selected, a display appears that shows the sample number (1 is the most recently stored sample, 16 is the oldest). Each stored event can be displayed by using the  and  buttons. The selected event can be deleted if desired.

The display for each event includes control mode, run mode, flow rate or pressure, total sampled volume, run time, pre and post calibrations, start/stop times, EN13137 status, and, for STP versions, average ambient temperature and pressure, STP volume and flow rate.

To **Review** the stored sample events:

1. At the Main Menu screen, use the  and  buttons to move the cursor  to **Review**. Press and release the  button.
2. Use the  and  buttons to select each sample event. There are eight lines of data for each event and the  and  buttons switch between the pages. Press and release the  button to exit **Review** and return to the Main Menu.

To delete an event being reviewed, scroll to the end of the Review menu and select the Delete Event item. Press the  button. A question box will pop up and allow the deletion of the event to be canceled or confirmed.

## SECTION SEVEN: PC Interface

---

### 7.1. PC Interface

The GilAir Plus Datalog and STP models have the capability of PC interface through the charging Dock. This requires a special communications version Dock that is supplied in kits with the Datalog and STP pump models. The basic model of the GilAir Plus does not have this capability, nor will the basic Dock supplied with the Basic model pump support this option.

The PC interface enables communication with the Gilian CONNECT pump management system. Gilian CONNECT provides the following capabilities:

- Download of event data, including summary and minute by minute datalogs from the pump to a data base
- Creation of field reports for each sample
- Editing and transfer of settings to the pump
- Export of event historical data in CSV file format for use in a PC spreadsheet application such as Excel™

Connecting the communications Dock to a PC requires USB cable P/N 811-0907-01-R. Each Docked pump is recognized by its serial number. A new pump must be registered before it will be recognized. The PC interface program format is summarized in the table below. A separate user manual (P/N 360-0143-01) describes the operation of Gilian CONNECT in detail.

Main Tabs	Sub Tabs	Function
Data Retrieval and Reports	Review Data from Logs	Download Sample Logs & Produce Field Reports and Graphs
Pump Manager	Manage Pump Information & Manage Pump Configuration	Manage pump setup and parameters
Program Manager	Manage Programming & Transfer Programs to Pump(s)	Create, Edit, Duplicate or Delete Sampling Programs; Transfer Programs to Pump(s)







**Note:** Please see the Gilian CONNECT Application User Manual for additional information.

## SECTION EIGHT: Maintenance Menu

### 8.1. Maintenance ►

The **Maintenance** submenu has controls that are occasionally used. These functions are used for clearing the GilAir Plus pump memories, calibrating transducers or performing other pump maintenance functions.

To change the settings for each item in the **Maintenance** submenu:

1. At the Main Menu screen, use the  and  buttons to move the cursor ► to **Maintenance** ►. Press and release the  button. The pump will now display the **Maintenance** submenu screen.
2. At the **Maintenance** submenu screen, use the  and  buttons to move the cursor ► to the desired submenu item. Each of the submenu items have additional menus or actions beneath them and are selected by pressing and releasing the  button.

### 8.2. Global Reset





**Global Reset** resets all user controlled parameters to the factory ship values.

Default factory values:

Parameter	Default Value
Flow Rate	2000 cc/min
Control Mode	CF
Run Mode	Manual
Point calibrations	nominal
Pressure setpoint	18 inches H2O
Timed start	8:00 am
Timed duration	1 minutes
Event enable	disabled
Events in Datalog	retains current data
Standard Temperature	25 degrees C
Standard Pressure	760 mmHg
Language display	English
Temperature Units	degrees C
Pressure Units	inches H2O
Password	disabled (0)
User Programs	cleared
Power source	NiMH
Contrast	10

To perform **Global Reset**:

**Note:** To preserve user programs, go to the Reset menu item instead of Global reset. (See Section 8.2.1.)

1. From the Main Menu screen, use the  and  buttons to move the cursor ► to **Maintenance** ►. Press and release the  button.
2. The pump will now display the **Maintenance** submenu screen. The cursor ► will be at **Factory Defaults** ►. Press and release the  button.
3. The cursor ► will now be at **Global reset**. Press and release the  button.
4. The following message box will appear:

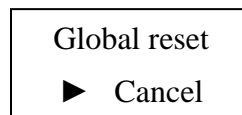

5. **Note:** To cancel out of **Global Reset**, press and release the  button or the  button at this time.
6. Press and release the  or  button. The message box now displays:

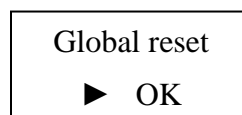







7. Press and release the  button. Global reset is now complete.



### 8.2.1. Reset (save programs)

Resets all user control parameters to factory ship values while preserving users programs.

To perform **Reset (save programs)**:

1. At the Main Menu screen, use the  and  buttons to move the cursor ► to **Maintenance** ►. Press and release the  button.
2. The pump will now display the **Maintenance** submenu screen. The cursor ► will now be at **Factory Defaults** ►. Press and release the  button.
3. The cursor ► will now be at **Global reset**. Use the  and  buttons to move the cursor ► to **Reset (save programs)**. Press and release the  button.
4. The following message box will appear:

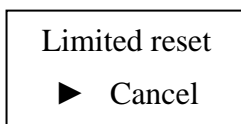

**Note:** To cancel out of **Reset (save programs)**, press and release the  button at this time.

5. Press and release the  or  button. The message box now displays:

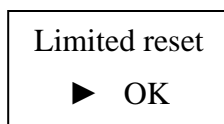







6. Press and release the  button. Limited reset is now complete.

### 8.2.2. Clear Datalog

**Clear Datalog** erases all datalog entries. When the datalog is full, any data saved in subsequent events will be lost. The datalog should be cleared after the data is extracted to allow space for new events. **The Datalog has the capacity to store up to 16 events.** The number of slots consumed in the datalog is shown on the Idle screen. Starting an event without space in the datalog will cause a warning screen. The datalog must be cleared to before initiating an event is possible. Transfer any required data to written records or use the PC app to transfer to the computer database.

To clear the datalog:

**IMPORTANT! Verify that all desired data has been archived prior to clearing!**

1. At the Main Menu screen, use the  and  buttons to move the cursor ► to **Setup** ►. Press and release the  button. The pump will now display the **Setup** submenu screen.
2. At the **Setup** submenu screen, use the  and  buttons to move the cursor ► to **Clear Datalog**. Press and release the  button. The following message box will be displayed:

Erase Datalog?  
► Cancel

**Note:** To cancel out of **Clear Datalog**, press and release the  button at this time.

3. Press and release the  or  button. The message box now displays:

Erase Datalog?  
► OK

4. Press and release the  button. The Datalog is now erased.







Erasing log  
95

The number shown is the percentage of the log remaining.

### 8.3. T ambient Cal ▶





Calibrates the ambient temperature sensor (available in STP version of the product). The calibration should be checked periodically, typically at the beginning of a sample run. Do not exceed six (6) months between calibrations of the ambient temperature sensor.

To perform **T ambient Cal**:

1. The pump should be idle and in a stable ambient temperature for at least one hour before this procedure. This ensures the ambient temperature sensor is not elevated by internal heating.
2. At the Main Menu screen, use the  and  buttons to move the cursor ▶ to **Maintenance ▶**. Press and release the  button. The pump will now display the **Maintenance** submenu screen. The cursor ▶ will now be at **Factory Defaults ▶**.
3. Use the  and  buttons to move the cursor ▶ to **T ambient Cal ▶**. Press and release the  button.
4. The following message box will appear:

Enter Ta (C) 27.1  
Ta Sensor (C) 23.6







**Note:** To cancel out of **T ambient Cal**, press and release the  button at this time.

5. Press and release the  or  button to adjust the “Enter Ta (C)” value to the current ambient temperature. Press and release the  button. The Ta sensor (C) will change to show the current measured ambient temperature after calibration.
6. Press and release the  button. Ambient temperature calibration is now complete.

## 8.4. Barometric P Cal ►





Calibrates the barometric pressure sensor (available in STP version of the product). The calibration should be checked periodically, typically at the beginning of a sample run. Do not exceed six (6) months between calibrations of the barometric pressure sensor.

To perform **Barometric P Cal**:

1. At the Main Menu screen, use the  and  buttons to move the cursor ► to **Maintenance** ►. Press and release the  button. The pump will now display the **Maintenance** submenu screen. The cursor ► will now be at **Factory Defaults** ►.
2. Use the  and  buttons to move the cursor ► to **Barometric P Cal** ►. Press and release the  button.
3. The following message box will appear:

Enter PB (mmHg)  
PB sensor (mmHg)

**Note:** To cancel out of **Barometric P Cal**, press and release the  button at this time.

4. Press and release the  or  button to adjust the “Enter PB (mmHg)” value to the current barometric pressure. Press and release the  button. The PB (mmHg) will change to show the current measured ambient barometric pressure after calibration.
5. Press and release the  button. Barometric pressure calibration is now complete.

## 8.5. Pressure ►

Calibrates the backpressure sensor. The calibration should be checked periodically, typically at the beginning of a sample run. Do not exceed six (6) months between calibrations of the backpressure sensor.







To perform **Pressure** calibration:

1. Set up the GilAir Plus pump, load panel and reference meters as shown. For this procedure, the pump must be set to the **Lo** range of operation. During the calibration, the pump will run and maintain 35 inches of water backpressure.
2. At the Main Menu screen, use the ▲ and ▼ buttons to move the cursor ► to **Maintenance** ►. Press and release the ⏻ button. The pump will now display the **Maintenance** submenu screen. The cursor ► will now be at **Factory Defaults** ►.
3. Use the ▲ and ▼ buttons to move the cursor ► to **Pressure** ►. Press and release the ⏻ button.
4. The following message box will appear:

Pressure inH2O 35

After a short delay, the pump will start to run at its internally calibrated value.

**Note:** To cancel out of **Pressure**, press and release the ⏪ button at this time.

5. Once the GilAir Plus pump pressure is stable press and release the  or  button to adjust the “Pressure” value to the pressure sensor reference meter reading. Press and release the  button. The pressure display will return to the original display with the calibration changed. Press and release the  button. The backpressure sensor calibration is now complete.

If a popup appears showing "Err" the calibration factor would have been changed by more than 5%. This is almost always an error, usually because the pressure had not stabilized. Wait for stability and try again.



## 8.6. Power Source

The Power Source item sets the type of power the pump uses. Choices are NiMH battery pack, AA replaceable cell pack and a DC power pack that operates on power from the Dock. If the selection is being made with the pump not on the Dock, the type of battery being selected will be validated and a warning message posted if the current battery pack does not match the selection. This may occur if the type is changed to prepare for a new power type such as in the process of changing to a DC power pack with a NiMH battery attached.

If a pump is mounted on a Dock and the power sources selected in the pump does not match the type reported by the Dock to the pump, the pump will attract attention by flashing its backlight and warn the user to remove the pump from the Dock. This is done to avoid having the Dock provide DC power to a NiMH pack which could, over a period of a couple of hours, damage the NiMH pack.

In software versions before 2.4, the DC power pack allows the pump to run indefinitely on the dock. Version 2.4 and higher, in combination with the version 3.5 Dock can support operation indefinitely with the NiMH battery. During operation the battery is trickle charged and will operate as a backup power supply if power fails.

## 8.7. Contrast

The contrast setting allows changing the LCD display contrast. It adjusts from 0 to 23, where 0 is minimum darkness and contrast and 23 is maximum. When adjusting the control, it can be adjusted with the  or  keys and will take effect when Enter is pressed. The ideal setting is having active pixels as dark as possible with no darkening of inactive pixels.

## SECTION NINE: User Maintenance

---

### 9.1. NiMH Battery Maintenance and Reconditioning

The NiMH battery pack provides service for 300 to 500 cycles depending on the conditions of use and storage.

The most common cause of battery life and charging issues is the battery contacts on the back of the pump becoming contaminated preventing a clean contact with the charging Dock contacts. If there is poor contact, charging may be reduced or not possible. The battery contacts can be cleaned with a pencil eraser. Never use a hard tool like a screwdriver or knife because the contacts may be damaged.

All rechargeable batteries lose charge over time even if not in use. This is called self-discharge. The self-discharge rate of the NiMH cells used in the GilAir Plus battery pack is about 1% per day. It is important to have the pack fully charged when starting a sample. To guarantee full charge, leave the pack or pump on the charging Dock until ready to use. Once the pump has charged completely, the charging Dock will change to a trickle charge mode that maintains the battery at maximum capacity.

If a battery pack goes unused and/or uncharged for more than three (3) weeks, it should be reconditioned by putting it on the charging Dock for 12 hours. The Dock will fast charge the battery and the additional trickle charge time will recondition it for maximum capacity. Remove the pump from the Dock and let it rest for at least one hour. Place it on the Dock for another charge cycle.

As the battery goes through charge/discharge cycles and ages, its capacity will diminish. If the battery is reconditioned as described above and does not result in expected run times, the battery has reached end of life and should be replaced.

The Dock will automatically perform a battery evaluation each time the battery pack is charged. Under certain conditions the Dock will perform a reconditioning of the battery cells in order to optimize the battery charge as a part of the normal charging routine. This one hour reconditioning step may result in slightly extended charging times. If the Dock detects a more serious battery condition it will provide an indication that a problem has been detected with the battery pack. See Appendix H for more information.

Battery life can be extended by storing in cool conditions. High temperatures can cause accelerated aging. DO NOT attempt to deep discharge the battery pack.

Battery packs manufactured after July 20, 2015 have several new capabilities listed below.

1. The packs support the new run on dock mode.
2. A reset capability is provided that will reset a hung processor without having to remove the battery pack from the pump. To perform a reset, short the charge terminals on the battery pack with a wire or paperclip. When shorted for 5 seconds, the processor power will be interrupted and reapplied when the short is removed.



3. Enhanced electronic protection for the protective fuse in the battery pack..
4. When the battery charge becomes dangerously low, it is internally interrupted to slow the deep discharge of the pack. This will be reset when the pack is charged.

## 9.2. Battery Replacement

To replace the battery pack, follow the steps below:

1. Remove the three case screws.
2. Remove the battery pack from the front case. Note that it is connected to the PC board by a wire harness.
3. Carefully unplug the wire harness, noting the position of the six pin connector.
4. Connect the new battery, observing the correct pin pattern.
5. Reconnect the case halves. Pay attention to wire routing so as not to pinch the wire harness. Also, be sure not to pinch or crimp any tubing connections.
6. Replace the case screws, and snug tighten only. Tighten until the gap between the case halves fully closes – **Do not over tighten**.
7. Charge the battery.



Step 1



Step 2

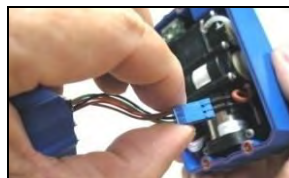

Steps 3-4

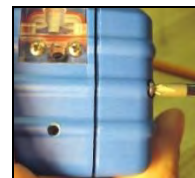

Steps 5-6

## 9.3. Pump Filter Maintenance

If the flow resistance of the input filter is too high, the sampling load capacity of the pump will be reduced. The status of the filter is easily determined. If the pressure drop across the filter is higher than 2 inches of water at a flow rate of 5000 cc/min, it should be replaced. To make this measurement, set the pump flow rate to 5000 cc/min running in constant flow mode. With nothing hooked to the inlet connector, the backpressure displayed on the pump should be less than 2 inches of water. If the Back Pressure is larger, replace the filter using the procedure below.

1. Remove the two screws from the filter housing.
2. Remove the filter housing by pulling straight out from the pump case.

3. Replace the filter P/N 811-0905-01R. Be sure it is properly positioned and gasket seal areas are clear (Gasket P/N 300-0103-01R). Insert the filter housing in the manifold. Note the proper positioning of the two o-rings, P/N 150-9106-50 R and 150-9121-50 R (Replace if damaged).
4. Re-attach the filter housing. Align outer gasket area first. Align filter housing exit connection and press inward until the o-rings are seated. Be sure the filter housing is fully seated before tightening screws.
5. Replace screws and snug tighten only. Do not over-tighten.



Step 1



Step 2



Step 3



Steps 4-5

## SECTION TEN: Appendices

---

Appendix A: Menu Outline

Appendix B: Example Program Setup & Edit

Appendix C: Barometric Compensation

Appendix D: Dual Port High/Low Flow Manifold

Appendix E: Troubleshooting Guide

Appendix F: Parts List

Appendix G: Specifications

Appendix H: Charging/Communications Dock

Appendix I: Factory Calibration and Service

## Appendix A: Menu Outline

---

Underlined option indicates factory default (shipped) settings

Run

Flow set (cc/min)

Calibrate

Setup ►

Event ID ( enable / disable )

Pre/Post cal ( enable / disable )

Fault retry ( enable / disable )

User Mode ( enable / disable )

Power-on Run ( enable / disable )

Event Lock ( enable / disable )

EN13137 ( enable / disable )

Valve mode ( Continuous / start/stop )

SmartCal ( Manual / Gilibrator / Challenger / TSI / BIOS Dfndr )

Clear Datalog

Run Options ►

Std Temp (°C) ( 25 )

Std P(mmHg) ( 760 )

Sensor option (All)

PaTa comp ( enable/disable)

Display Options ►

Language ( English / Espanol / Deutsch / Francais / Italiano / Dutch / Portugues / Turkish)

Temperature Units ( C / F )

Pressure Units ( "H<sub>2</sub>O / mmHg / KPa / mbar)

AP units ( "H<sub>2</sub>O / mmHg / KPa / mbar)

Clock Set ►

Clock ( hours:minutes:seconds )

Date ( mmm, dd yyyy )

Time format ( 24h / 12h )

Date format	( <u>mm/dd/yy</u> / dd/mm/yy )
Password	( <u>0</u> )
Control Mode	( <u>CE</u> / CPL / CPH )
Run Mode	( <u>Manual</u> / Timed / Vol / RT / PROG01 ... PROG16)
Run Setup ▶	
T/V/RT start	( <u>08:00:00</u> )
Timed Duration	( <u>1</u> )
Vol Set	( <u>1</u> )
RT	( <u>1</u> )
Press set     " H <sub>2</sub> O	( <u>18.0</u> )
Program Edit ▶	
Prog Name	( <u>PROG01</u> ... PROG16 )
Control Mode	( <u>CE</u> / CPL / CPH )
Setpoint	( <u>2000</u> )
Prog Step	( <u>1</u> )
Function	( <u>End</u> / On Interval / Off Interval / Cycle / Time / Date / Weekday / Vol / RT )
Value	( options in section 6.9)
Save	( <u>_</u> / Changed )
Review	
Maintenance ▶	
Factory Defaults ▶	
Global reset ▶	
Reset (save programs) ▶	
Clear Datalog	
T ambient Cal ▶	
Barometric P Cal ▶	
Pressure ▶	
Power Source	( <u>NiMH</u> / AA / DC )
Contrast	( <u>10</u> )

## Appendix B: Example Program Setup & Edit

---































































This example program operates the pump as follows:

- The pump must be calibrated per Section 4.9.2. and 4.9.3. to run at a flow rate of 3000 cc/min.
- Control mode is set to CF (Constant Flow Mode).
- Flow rate is set to 3000 cc/min.
- The program starts with an On Interval at 4:00 PM (16:00 Hrs).
- The On Interval lasts for 1 minute, then an Off Interval begins and the pump stops running.
- The Off Interval lasts for 1 minute and then repeats the entire program for 2 cycles.

### ENTER AND RUN THE PROGRAM

**Note:** The program must be saved before leaving the entry/edit process to transfer it to storage. If the program is not saved, it will be lost. Some users may want to save the program at each edit step. Saving the program after entry and editing before exiting will store the entire program.

1. At the Main Menu screen, use the and buttons to move the cursor ▶ to **Run Setup** ▶. Press and release the button. Use the and buttons to move the cursor ▶ to **Program** ▶. Press and release the button.
2. Use the and buttons to move the cursor ▶ to **Program Edit** ▶. Press and release the button.
3. The cursor ▶ is now at **Prog Name**. Use the and buttons to select the program name. Press and release the button. Select **PROG01** to appear to the right of **Prog Name**.
4. Use the and buttons to move the cursor ▶ to **Control Mode**. Use the and buttons to set the Control Mode to CF (Constant Flow). Press and release the button.
5. Use the and buttons to move the cursor ▶ to **Setpoint**. Use the and buttons to set the set point flow rate to 3000 cc/min. Press and release the button.
6. Use the and buttons to move the cursor ▶ to **Prog Step**. Use the and buttons to set the program step to 1.
7. Use the and buttons to move the cursor ▶ to **Function**. Use the and buttons to set the function to **Time**. Press and release the button.

8. Use the  and  buttons to move the cursor ► to **Value**. Use the  and  buttons to set the hour to 16:00 or 4:00 PM. Press and release the  button. Use the  and  buttons to set the minutes to 00. Press and release the  button. 16:00 or 4:00 PM is now the displayed program start time.
9. Use the  and  buttons to move the cursor ► to **Save**. Press and release the  button.
10. Use the  and  buttons to move the cursor ► back up to **Prog Step**. Use the  and  buttons to set the program step to 2.
11. Use the  and  buttons to move the cursor ► to **Function**. Use the  and  buttons to set the function to Cycle. Press and release the  button.
12. Use the  and  buttons to move the cursor ► to **Value**. Use the  and  buttons to set the value to 0. Press and release the  button.
13. Use the  and  buttons to move the cursor ► to **Function**. Use the  and  buttons to set the function to On Interval. Press and release the  button.
14. Use the  and  buttons to move the cursor ► to **Value**. Use the  and  buttons to set the On Interval to 1. Press and release the  button.
15. Use the  and  buttons to move the cursor ► back up to **Prog Step**. Use the  and  buttons to set the program step to 3.
16. Use the  and  buttons to move the cursor ► to **Function**. Use the  and  buttons to set the function to Off Interval. Press and release the  button.
17. Use the  and  buttons to move the cursor ► to **Value**. Use the  and  buttons to set the Off Interval to 01. Press and release the  button.
18. Use the  and  buttons to move the cursor ► back up to **Prog Step**. Use the  and  buttons to set the program step to 4.
19. Use the  and  buttons to move the cursor ► to **Function**. Use the  and  buttons to set the function to Cycle. Press and release the  button.
20. Use the  and  buttons to move the cursor ► to **Value**. Use the  and  buttons to set the Cycle to 2. Press and release the  button.



21. Use the and buttons to move the cursor ▶ to **Save**. Press and release the button.
22. Press the button 3 times to exit to the Main Menu. Use the and buttons to move the cursor ▶ to Run Mode. Use the and buttons to set the Run Mode to **PROG01**. Press and release the button. If **PROG01** is not available in the Run Mode, the programs have not been enabled. (See Section 1.1. )
23. Use the and buttons to move the cursor ▶ to **Run**. Press and release the button. The pump will then display the Event ID screen (if the Event function has been enabled see Section 5.2. ). If Event has been enabled, enter the Event ID and press and release the button. The pump now displays the Program screen, the event starts, and the pump will begin to run at the displayed start time (16:00). If the current time is later than 16:00, the next step will start immediately.

## EDITING THE PROGRAM

To change the number of cycles in the program from 2 cycles to 3 cycles, perform the following steps:















1. At the Main Menu screen, use the and buttons to move the cursor ▶ to **Run Setup** ▶. Press and release the button. Use the and buttons to move the cursor ▶ to **Program Edit** ▶. Press and release the button.
2. The cursor ▶ is now at **Prog Name**. Use the and buttons to select **PROG01** for the program name. Press and release the button. **PROG01** now appears to the right of **Prog Name**.

**IMPORTANT! – To edit an already existing program, you must correctly select the program name of the program you wish to edit. Otherwise, you may inadvertently edit the wrong program!**

In this example, only one program was entered and stored into the pump. When the program was entered, it was entered into the program name **PROG01** (any other name could have been assigned as well, i.e. – **PROG03**). Enter **PROG01** to edit the program with the unique name **PROG01**.

**Note:** The pump provides program names PROG01 - PROG16, other program identifiers can be assigned via the PC Application Program Manager.

To change the number of cycles in **PROG01**, access the Program Step where the Cycle function was entered. For the example program, the Cycle function was selected at Program Step 4.

1. Use the  and  buttons to move the cursor ► to **Prog Step**. Use the  and  buttons to set the program step to 4.
2. Use the  and  buttons to move the cursor ► to **Function**. Verify that the setting assigned to Function for Program Step 4 is Cycle.
3. Use the  and  buttons to move the cursor ► to **Value**. Use the  and  buttons to change the Function value from 2 to 3. Press and release the  button.
4. Use the  and  buttons to move the cursor ► to **Save**. Press and release the  button. The change from 2 cycles to 3 cycles for the program named **PROG01** has now been successfully entered and stored. Press and release the  button 3 times to exit to the Main Menu.

## SAMPLE PROGRAMS

This section contains several sample programs illustrating common program uses. The examples are intended to illustrate the use of each type of program step.

The programming examples below are presented in tabular form using 12 hour clock display. The first three columns provide the information necessary to enter each step. The next three columns interpret each step, and a summary of the program appears below each table.

**Note:** The pump will start the program when the run key is pressed. If the time specified in the program has already passed the program will continue to the next step. This will continue until the end statement is reached. Clock can be displayed in 12 hour or 24 hour time format. (See Section 5.14.3. )

### Basic Program (similar to Timed mode)

Program Step	Function	Value	Starts at Run Start	Ends At	Pump Action
1	Time	8:00 AM	Run key	8:00 AM	Off
2	On Interval	480 (min.)	8:00 AM	4:00 PM	On
3	End	0	4:00 PM	4:00 PM	Prog End

This program waits until 8:00 AM is past on the current day, then turns the pump on until 4:00 PM (480 minutes, 8 hours) later. At 4:00 PM the program ends.

### Timed with multiple sampling periods

Program Step	Function	Value	Starts at Run Start	Ends At	Pump Action
1	Time	8:00 AM	Run key	8:00 AM	Off
2	On Interval	240 (min.)	8:00 AM	12:00 PM	On
3	Off Interval	60 (min.)	12:00 PM	1:00 PM	Off
4	On Interval	240 (min.)	1:00 PM	5:00 PM	On
5	End	0	5:00 PM	5:00 PM	Prog End

This program waits until 8:00 AM is past on the current day, then turns the pump on until 12:00 PM (240 minutes, 4 hours) later. The pump stays off until 1:00 PM, and then turns on until 5:00 PM. At 5:00 PM the program ends.

### Date and time

Program Step	Function	Value	Starts at Run Start	Ends At	Pump Action
1	Date	May 1, 2012	Run key	May 1, 2012	Off
2	Time	8:00 AM	May 1, 2012 12:00 AM	8:00 AM	Off
3	On Interval	240 (min.)	8:00 AM	12:00 PM	On
4	Off Interval	60 (min.)	12:00 PM	1:00 PM	Off
5	On Interval	240 (min.)	1:00 PM	5:00 PM	On
6	End	0	5:00 PM	5:00 PM	Off

This program waits until midnight on the specified day, then waits until 8:00 AM on that day, then turns the pump on until 12:00 PM (240 minutes, 4 hours) later. The pump stays off until 1:00 PM, and then turns on until 5:00 PM. At 5:00 PM the program ends.

### Day of week

Program Step	Function	Value	Starts at Run Start	Ends At	Pump Action
1	Weekday	Mon	Run key	Next Monday	Off
2	Time	8:00 AM	Monday 12:00 AM	8:00 AM	Off
3	On Interval	240 (min.)	8:00 AM	12:00 PM	On
4	Off Interval	60 (min.)	12:00 PM	1:00 PM	Off
5	On Interval	240 (min.)	1:00 PM	5:00 PM	On
6	End	0	5:00 PM	5:00 PM	Prog End

This program waits until midnight is past on Monday, waits until 8:00 AM, then turns the pump on until 12:00 PM (240 minutes, 4 hours) later. The pump stays off until 1:00 PM, and then turns on until 5:00 PM. At 5:00 PM the program ends.

### Multiple day of week

Program Step	Function	Value	Starts at Run Start	Ends At	Pump Action
1	Weekday	Mon	Run key	Monday 12:00 AM	Off
2	Time	8:00 AM	Monday 12:00 AM	8:00 AM	Off
3	On Interval	480	8:00 AM	12:00 PM	On
4	Off Interval	60	12:00 PM	1:00 PM	Off
5	On Interval	240	1:00 PM	5:00 PM	On
6	Weekday	Tue	Monday 5:00 PM	Tuesday 12:00 AM	Off
7	Time	8:00 AM	Tuesday 12:00 AM	8:00 AM	Off
8	On Interval	240	8:00 AM	12:00 PM	On
9	Off Interval	60	12:00 PM	1:00 PM	Off
10	On Interval	240	1:00 PM	5:00 PM	On
11	Weekday	Thu	Tuesday 5:00 PM	Thursday 12:00 AM	Off
12	Time	8:00 AM	Thursday 12:00 AM	8:00 AM	Off
13	On Interval	240	8:00 AM	12:00 PM	On
14	Off Interval	60	12:00 PM	1:00 PM	Off
15	On Interval	240	1:00 PM	5:00 PM	On
16	Weekday	Fri	Thursday	Friday	Off

			5:00 PM	12:00 AM	
17	Time	8:00 AM	Friday 12:00 AM	8:00 AM	Off
18	On Interval	240	8:00 AM	12:00 PM	On
19	End	0	12:00 PM	12:00 PM	Off

If this program is started anytime Tuesday to Sunday, it waits until midnight is past on Monday, waits until 8:00 AM, then turns the pump on until 12:00 PM (240 minutes, 4 hours) later. The pump stays off until 1:00 PM, and then turns on until 5:00 PM. The cycle repeats on Tuesday, Thursday and Friday. At Friday 12:00 PM the program ends.

### Intermittent sampling (single)

Program Step	Function	Value	Starts at Run Start	Ends At	Pump Action
1	On Interval	6 (min.)	Run key	+ 6 min	On
2	Off Interval	54 (min.)	+6min	+60 min	Off
3	Cycle	10 (Total Iterations)			On
4	End	0	600 min	600 min	Off

This program samples for six minutes of each hour for 10 hours, accumulating 60 minutes of run time distributed across the 10 hours.

### Intermittent sampling (multiple)

Program Step	Function	Value	Starts at Run Start	Ends At	Pump Action
	Time	8:00 AM	Run key	8:00 AM	Off
1	On Interval	6 (min.)		+ 6 min	On
2	Off Interval	54 (min.)	+6min	+60 min	Off
3	Cycle	4 (Total Iterations)			On
1	Off Interval	54 (min.)	+6min	+60 min	On
3	Cycle	0			On
1	On Interval	6 (min.)	+6min	+60 min	On
1	Off Interval	54 (min.)	+6min	+60 min	On
3	Cycle	4 (Total Iterations)			On
4	End	0	5:00 PM	5:00 PM	Off

This program waits until 8:00 AM is past on the current day, then turns the pump on for the first 6 minutes of each hour until 12:00 PM. The pump stays off until 1:00 PM, then turns on for the first 6 minutes of each hour until 5:00 PM. At 5:00 PM the program ends.

## Appendix C: Barometric Compensation

---

The GilAir Plus barometric pressure compensation feature allows the pump to be moved after calibration to another environment with different temperature and pressure with a minimal effect on the ambient flow rate. This compensation is available for operation at flow rates from 450 cc/min to 5100 cc/min.

Good Industrial Hygiene practice dictates the sampling pump be calibrated immediately before use in the environment where the sampling event will take place. The compensation feature will allow much more accurate sample flow rate control in sampling environments with varying pressure and temperature such as an airplane in flight or where on the spot calibration is difficult, such as a mine.

The compensation feature can be enabled if the pump is calibrated at one set of environmental conditions with flow rates from 450 cc/min to 5100 cc/min. With the feature activated the ambient conditions flow rate will not vary by more than 5% due to change in temperature or pressure, within specified flow rate and barometric pressure limits. In order to use this feature the pump must be calibrated at the flow rate required and the event started. The calibration can be done manually or by using the "Pre/Post Cal" mode.

### Implementation:

A menu item has been included in the Setup>Run Options: PaTa Comp, to enable or disable the compensation. A display screen has been added to show the compensation conditions and factors. The display is visible only when using the display selection controls; it does not appear in the normal sequence of operations.

When the feature is disabled the pump holds stable calibration at constant barometric pressure and ambient temperature. When enabled the compensation feature activates the changes in operation as listed below.

- When the flow rate is changed, a 3 second popup message will appear reminding the user to calibrate the flow.
- If an event is started without its last calibration at the event flow rate, a popup message will appear reminding the user that calibration is required and the event will not start. Regardless of how the event is started, including Run on Powerup.
- The internal controls will be enabled to compensate the pump for changes in barometric pressure and temperature. The calibration pressure (Pc) and temperature (Tc) and current conditions (Pa, Ta) and flow correction factor are displayed if the PaTa compensation screen is selected.

## Appendix D: Dual Port High/Low Flow Manifold

---

### Dual Port High/Low Flow Manifold

- Dual air sampling with one personal pump
- Sample with two filter cassettes, or one filter and one sorbent tube simultaneously
- Sample for heavy metals, asbestos, and organic solvents in tandem in any combination
- Saves time and money

Sensidyne's Dual Port High/Low Flow Manifold is used in conjunction with the GilAir Plus pump's high flow constant pressure capability, a part of the Quad Flow feature. The GilAir Plus pump can accommodate constant pressure control in the high flow mode (up to 5100 cc/min.), allowing dual simultaneous samples of such airborne contaminants as heavy metals (e.g., lead) or asbestos fibers. With the Dual Port High Flow Manifold, the GilAir Plus can also accommodate one high flow and one low flow sample simultaneously (e.g., lead and benzene) using a filter cassette and a charcoal tube in tandem.

The Dual Port High/Low Flow Manifold allows separate flow settings on a split sample making dual sampling possible. The constant pressure control maintains a constant negative pressure in the sample train between the pump and the manifold, so that the force driving the samples does not change. Adjusting the flow on one side does not affect the other. Similarly, sample media loading on one side does not affect the other. Any sampling method that does not undergo a large backpressure change from start to finish may be accomplished using this system. (Sampling for dust in this mode requires careful consideration of pressure capabilities and possible changes in resistance and is not recommended).

To operate the Dual Port High/Low Flow Manifold with the GilAir Plus pump series, follow the steps below.

1. Set the GilAir Plus pump to operate in the constant-flow high-flow (CFH) mode.
2. Attach the Dual Port High/Low Flow Manifold using the ¼ inch tubing provided. The manifold should be mounted at the worker's lapel so as to represent the breathing zone. Note that the manifold is available in two configurations, allowing the choice of running the tubing over the shoulder (top access) or under the shoulder (bottom access).
3. Using the Gilibrator-2 or equivalent air flow calibrator with very low pressure drop, measure the flow rate at the sample inlet, and adjust the flow rates individually using the splitter's needle valves.
4. Two simultaneous filter samples may run up to 2 LPM each.



For further information, see the GilAir Plus operations manual and the technical paper, *GilAir Plus Quad Mode – Split Sampling in the High Flow Mode*.

## PERFORMANCE SPECIFICATIONS

---

Size dimensions, top access model.....	58 x 42 x 23 mm
Size dimensions, bottom access model.....	58 x 63 x 16 mm
Weight.....	53 grams
Number of simultaneous samples.....	2
Flow control range, each channel.....	1 to 4000 cc/min

## Appendix E: Troubleshooting Guide

Symptom	Possible Cause	Corrective Action
“Connect Media” message appears intermittently.	The GilAir Plus is seeing a back pressure less than 1 inch of water, an indication that no sample train is connected. The message only appears during high flow sampling 450 cc/min and higher, is informative and does not affect the sampling.	Connect a sample train to the pump inlet.
Run time too short; does not meet projected run time	Battery Pack not fully charged.	Charge battery (Sec. 3.1. Appendix G)
	Batteries have deeply discharged. Battery pack may need to be reconditioned.	Recondition battery pack (Sec. 9.1. ). Store pumps on energized docking stations (version 3.2 and higher) when not in use. If dock does not have a revision sticker on bottom , Return dock for service
	Battery pack capacity too low, at end of life	Replace battery (Sec. 9.2. )
	Battery contacts contaminated.	Clean charging contacts(App H)
	Bent battery belt clip preventing effective charging on docking station	Replace battery (Sec. 9.2. ) Replace belt clip (for batteries with replaceable belt clips)
Pump will not turn on	Low battery charge	Charge battery (Sec. 3.1. )
	Blown fuse in battery	Replace battery (Sec. 9.2. )
	Dead Cell in battery	Replace battery (Sec.9.2. )
	Control board problem	Return for service
	Processor Lock-up due to deep discharge	Recondition battery pack (Sec 9.1. ) Disconnect battery and reconnect (Sec. 9.2. ) If battery pack has manufacture date after 2815 (made after July 15 2015), the processor can be

Symptom	Possible Cause	Corrective Action
		reset by shorting the charge terminals with a wire or paperclip. See Appendix H.
Backlight on but no text	Insufficient LCD drive voltage from battery pack	Replace battery (Sec. 9.2. )
Pump shows Fault in display/Enters HOLD	Inlet filter clogged	Replace Filter (Sec. 9.3. )
	Intake obstructed	Examine sample holder and remove obstruction or run at lower flow rate
	Control board problem	Return for service
	Valve change during operation	Valve cannot be changed during sample, only before starting event
	Valve error shown, no valve change attempted	Valve may be affected by strong magnetic fields (Sec. 5.9. )
	Low battery	Charge battery (Sec. 3.1. )
	Flow rate is set too high for sample media	Correct the flow rate per sample method guidelines
	Sample media tubing pinched shut	Correct tubing obstruction
Pump runs flat out	Internal flow transducer problem	Backpressure too high; remove restriction or lower flow rate
	Control board problem	Return for service
	Improper Calibration	Recalibrate Pump (Sec. 4.9.3. )
Pump runs erratic & faults	Faulty bearing	Return for service
	Faulty motor	Return for service
	Liquid in pump or other matter	Return for service
	Dock connected	Don't run pump with Dock Connected. Note, if running a pump with version 2.4 or higher software and using a dock of version 3.5 or higher, the pump is supported to run on dock and this is not the reason for the problem.
	Insufficient backpressure for stable operation	Check sample media or increase flow rate (minimum back pressure requirement is 2 inches of water)

Symptom	Possible Cause	Corrective Action
Pump does not achieve flow specifications	Valve dirty or torn	Return for service
	Torn diaphragm on yoke assembly	Return for service
	Leak in pump	Tighten input manifold screws. Tighten screws to snug tight only. Do not over tighten. Return for service if tightening screws does not solve leakage issue. (Sec. 9.3. )
	Battery not sufficiently charged	Charge battery (Sec. 3.1. )
Pump surges	Display calibration adjusted out of range	Reset display calibrations to factory setting (Sec. 8.2. )
	Dock connected	Don't run pump with Dock connected (for Pumps with firmware version below 2.4)
Pump will not run program	Program time is set to zero	Enter non zero program duration (Sec. 6.1. )
	Program not selected in run mode	Check run setup (Sec. 5.18. )
	Not DL or STP Model	Upgrade to DL or STP model
	Keypad is locked	Unlock Keypad (Sec. 4.7.3. ) If a password is required, enter the password. The override password is 9999.If the password has been forgotten, shame on you. Try using 9999 as a password.
Keypad inoperative	Pump in off phase of program	Wait for program to complete program or stop program
	Normal self-check function. Flow control is being re-zeroed.	None (Sec. 4.5.9. ) Sensor calibration can be set for three modes, See section 4.6.

Symptom	Possible Cause	Corrective Action
Pump stops occasionally and restarts after 20 seconds	Flow display is out of calibration	Calibrate flow display (Sec. 4.9.3. )
Displayed flow rate does not match calibration	Wrong sample tube holder selected for constant pressure control adapter	Select tube holder that incorporates a needle valve
Pump will not run at desired flow rate in low flow mode	Flow valve not in correct mode	Reset valve (Sec. 4.8.1. )
Pump does not start, "Change Valve" displayed	Device communication error	Check that calibration device is powered, turned on and cable is connected from calibrator to Dock. Check that correct calibrator is selected in Setup/SmartCal menu item. Must use rearmost station in multiposition Dock (Sec. 5.10. )
In SmartCal, "Check Device" displayed or no flow readings	Battery was deeply discharged due to lack of use, has reached the end of its useful life, or is damaged	Recondition battery (Sec. 9.1. )
Pump continuously displays 'NIMH analysis' with 1 second Red LED during "Fast charge, Top-off, or Trickle charge phase	Dock reports a power source different than selected in the pump.	If displayed message from the Dock is not the same as set in the pump, change pump if setting is wrong. If Dock reports different from actual type, remove and reseal pump. If problem persists, replace battery pack.
Pump displays "Power mismatch" and flashes backlight when placed on Dock	The requested change is a change of more than 5%, an unusual condition.	Allow more time for the pump to stabilize and try again. If problems persist, call Sensidyne for advice and service.
Pump displays "Err" when calibrating back pressure		

## Appendix F: Parts List

---

Part Number	Description
810-0901-01-R	Basic Pump Only (No Dock)
810-0902-01-R	Datalogging Pump Only (No Dock)
810-0903-01-R	STP Pump Only (No Dock)
910-0901-US-R	GilAir Plus Basic Single Starter Kit, US cord
910-0901-EU-R	GilAir Plus Basic Single Starter Kit, Euro cord
910-0901-UK-R	GilAir Plus Basic Single Starter Kit, UK cord
910-0902-US-R	GilAir Plus Datalogging Single Starter Kit, US cord
910-0902-EU-R	GilAir Plus Datalogging Single Starter Kit, Euro cord
910-0902-UK-R	GilAir Plus Datalogging Single Starter Kit, UK cord
910-0903-US-R	GilAir Plus STP Single Starter Kit, US cord
910-0903-EU-R	GilAir Plus STP Single Starter Kit, Euro cord
910-0903-UK-R	GilAir Plus STP Single Starter Kit, UK cord
910-0907-US-R	GilAir Plus Basic 3-Pump Starter Kit, US cord
910-0907-EU-R	GilAir Plus Basic 3-Pump Starter Kit, Euro cord
910-0907-UK-R	GilAir Plus Basic 3-Pump Starter Kit, UK cord
910-0908-US-R	GilAir Plus Datalogging 3-Pump Starter Kit, US cord
910-0908-EU-R	GilAir Plus Datalogging 3-Pump Starter Kit, Euro cord
910-0908-UK-R	GilAir Plus Datalogging 3-Pump Starter Kit, UK cord
910-0909-US-R	GilAir Plus STP 3-Pump Starter Kit, US cord
910-0909-EU-R	GilAir Plus STP 3-Pump Starter Kit, Euro cord
910-0909-UK-R	GilAir Plus STP 3-Pump Starter Kit, UK cord

Part Number	Description
910-0904-US-R	GilAir Plus Basic 5-Pump Starter Kit, US cord
910-0904-EU-R	GilAir Plus Basic 5-Pump Starter Kit, Euro cord
910-0904-UK-R	GilAir Plus Basic 5-Pump Starter Kit, UK cord
910-0905-US-R	GilAir Plus Datalogging 5-Pump Starter Kit, US cord
910-0905-EU-R	GilAir Plus Datalogging 5-Pump Starter Kit, Euro cord
910-0905-UK-R	GilAir Plus Datalogging 5-Pump Starter Kit, UK cord
910-0906-US-R	GilAir Plus STP 5-Pump Starter Kit, US cord
910-0906-EU-R	GilAir Plus STP 5-Pump Starter Kit, Euro cord
910-0906-UK-R	GilAir Plus STP 5-Pump Starter Kit, UK cord
811-0901-US-R	Single Station Basic Dock 100-240Vac, 50-60 Hz, US Cord (includes Power Supply)
811-0901-EU-R	Single Station Basic Dock 100-240Vac, 50-60 Hz, Euro Cord (includes Power Supply)
811-0901-UK-R	Single Station Basic Dock 100-240Vac, 50-60 Hz, UK Cord (includes Power Supply)
811-0911-US-R	Three Station Basic Dock 100-240Vac, 50-60 Hz, US Cord. (includes Power Supply)
811-0911-EU-R	Three Station Basic Dock 100-240Vac, 50-60 Hz, Euro Cord. (includes Power Supply)
811-0911-UK-R	Three Station Basic Dock 100-240Vac, 50-60 Hz, UK Cord. (includes Power Supply)
811-0902-US-R	Five Station Basic Dock 100-240Vac, 50-60 Hz, US Cord. (includes Power Supply)
811-0902-EU-R	Five Station Basic Dock 100-240Vac, 50-60 Hz, Euro Cord. (includes Power Supply)
811-0902-UK-R	Five Station Basic Dock 100-240Vac, 50-60 Hz, UK Cord. (includes Power Supply)
811-0903-US-R	Single Station Dock w/Comms 100-240Vac, 50-60 Hz, US Cord (includes Power Supply)



Part Number	Description
811-0903-EU-R	Single Station Dock w/Comms 100-240Vac, 50-60 Hz, Euro Cord (includes Power Supply)
811-0903-UK-R	Single Station Dock w/Comms 100-240Vac, 50-60 Hz, UK Cord (includes Power Supply)
811-0912-US-R	Three Station Dock w/Comms 100-240Vac, 50-60 Hz, US Cord (includes Power Supply)
811-0912-EU-R	Three Station Dock w/Comms 100-240Vac, 50-60 Hz, Euro Cord (includes Power Supply)
811-0912-UK-R	Three Station Dock w/Comms 100-240Vac, 50-60 Hz, UK Cord (includes Power Supply)
811-0904-US-R	Five Station Dock w/Comms 100-240Vac, 50-60 Hz, US Cord (includes Power Supply)
811-0904-EU-R	Five Station Dock w/Comms 100-240Vac, 50-60 Hz, Euro Cord (includes Power Supply)
811-0904-UK-R	Five Station Dock w/Comms 100-240Vac, 50-60 Hz, UK Cord (includes Power Supply)
811-0908-US-R	Power Supply, Single Station 100-240Vac, 50-60 Hz, US Cord
811-0908-EU-R	Power Supply, Single Station 100-240Vac, 50-60 Hz, EU Cord
811-0908-UK-R	Power Supply, Single Station 100-240Vac, 50-60 Hz, UK Cord
811-0909-US-R	Power Supply, 3/5 -Station 100-240Vac, 50-60 Hz, US Cord
811-0909-EU-R	Power Supply, 3/5 -Station 100-240Vac, 50-60 Hz, EU Cord
811-0909-UK-R	Power Supply, 3/5 -Station 100-240Vac, 50-60 Hz, UK Cord
780-0015-01-R	Calibrator cable (Gilibrator), for SmartCal option
780-0015-02-R	Calibrator cable (Challenger®), for SmartCal option
780-0015-03-R	Calibrator cable (TSI™), for SmartCal option
780-0015-04-R	Calibrator cable (BIOS Defender™), for SmartCal option
783-0012-01-R	Battery Pack NiMH Rechargeable
783-0013-01-R	Battery Pack AA Alkaline (Primary Cells)

Part Number	Description
783-0014-01-R	Battery Pack Bench Top DC Power Pack (for area sampling only).
811-0934-01-R	Belt Clip w/ screws, GilAir Plus
811-0907-01-R	Dock to PC, USB cable (w/inductor), for Com version Dock only
811-0905-01-R	Inlet Filters, Replacement, Pack of 10
360-0132-01	Operation Manual
360-0135-01	Quick Start Guide
360-0143-01	PC Application Manual
811-0913-01-R	Outlet Fitting, Bag Fill Adapter
811-0914-01-R	Tripod Mount, Adapts pump to camera style tripod, GilAir/GilAir Plus/3500/5000
800573-3	Diagnostic Panel
800783-3	Diagnostic Panel with Stand
800143	Filter Cassette Holder Kit
800149	Single Tube Holder Kit, 6 x 70, for 150 mg Activated Charcoal tube
297-0006-01-R	Power Cord, Dock, US
297-0007-01-R	Power Cord, Dock, Euro
297-0008-01-R	Power Cord, Dock, UK
911-0902-01-R	Dual Port High/Low Flow Manifold Kit, Top Access 1 ea. Dual Port High/Low Flow Manifold Kit Top Access with Tubing 2 ea. Sorbent tube adapter nipple for Dual Port High Flow Manifold 1 ea. Sorbent Tube Holder, 6 x 70 mm, for Standard Charcoal Tube 1 ea. Luer Fittings (Pk of 6) 2 ea. 1/4 inch ID Flexible Vinyl Tubing, 1.5 inch length
911-0901-01-R	Dual Port High/Low Flow Manifold Kit, Bottom Access 1 ea. Dual Port High/Low Flow Manifold Kit Top Access with Tubing 2 ea. Sorbent tube adapter nipple for Dual Port High Flow Manifold 1 ea. Sorbent Tube Holder, 6 x 70 mm, for Standard Charcoal Tube 1 ea. Luer Fittings (Pk of 6) 2 ea. 1/4 inch ID Flexible Vinyl Tubing, 1.5 inch length

Part Number	Description
811-0919-01-R	Dual Port High/Low Flow Manifold Kit only, Top Access with Tubing
811-0918-01-R	Dual Port High/Low Flow Manifold Kit only, Bottom Access with Tubing
800165	Sorbent tube adapter nipple for Dual Port High Flow Manifold, ea
800165-10	Sorbent tube adapter nipple for Dual Port High Flow Manifold, (10/pk)
800149	Sorbent Tube Holder, 6 x 70 mm, for Standard Charcoal Tube
200484	1/4 inch ID Flexible Vinyl Tubing, 3 feet
6667-6206	1/4 inch ID Flexible Vinyl Tubing, 1.5 inch length
811-0920-01	Replacement Valve Caps (Pack of 2)
200156-6	Luer Fittings (Pk of 6)

## Appendix G: Specifications

---

### PERFORMANCE

---

Flow Range.....	20 - 5100 cc/min (450 - 5100 cc/min in Constant Flow High Flow mode, 20-4459 cc/min in Constant Flow Low Flow mode) 1-5000 cc/min in Constant Pressure mode
Flow Modes.....	High and Low Flow Constant Flow or Constant Pressure
Flow Display.....	± 5% of set flow or ±3 cc/min whichever is higher
Constant Flow Control.....	± 5% of set flow or ±3 cc/min whichever is higher from minimum pressure of 2 "H2O to specified maximum
Constant Pressure Control...	± 10% of back-pressure

Run Time/Back Pressure Capability.....	Flow Range	BP for 8 Hrs	Fault
	5000 cc/min	12" H2O	minimum 15" H2O
	4000 cc/min	20" H2O	minimum 30" H2O
	3000 cc/min	30" H2O	minimum 35" H2O
	2000 cc/min	30" H2O	minimum 40" H2O
	1000 cc/min	35" H2O	minimum 40" H2O
	450-999 cc/min	40" H2O	minimum 40" H2O
	20-445 cc/min	40" H2O	minimum 40" H2O

Flow Fault..... If flow changes exceed 5% within backpressure specifications, fault notification appears. If fault exceeds 30 seconds, pump shuts down. Selectable automatic fault recovery allows the pump to attempt restart every 3 minutes for up to 10 times or to hold until manual intervention.

**BAROMETRIC PRESSURE COMPENSATION (STP ONLY)**

---

Correction Accuracy..... After calibration at the desired flow rate, the flow will not vary by more than 5% if the barometric pressure is in the range specified below.

Barometric Pressure Range.. 560mmHg to 1160mmHg

Temperature Range..... 32°F to 113°F (0°C to 45°C)

## ENVIRONMENTAL

---

### Temperature Ranges

Operating.....	32°F to 113°F (0°C to 45°C)
Storage.....	-4°F to 113°F (-20°C to 45°C)
Charging.....	41°F to 104°F (5°C to 40°C)

### Humidity Ranges

Operating.....	5-95 %RH, non-condensing
Storage.....	5-98 %RH, non-condensing

## GENERAL

---

RoHS Compliant.....	European and China, without taking advantage of product use exemptions listed for use in both unclassified and hazardous classified areas
Display.....	Flow rate, sample time, and sample volume in actual conditions
Indicators.....	Green and Red LED's
Dimensions.....	4.3W x 2.4H x 2.4D inches (11.0W x 6.1H x 6.1D cm)
Weight.....	20.5 oz. (580 g)
Hex Key.....	2 mm or 5/64 inch hex

## ELECTRICAL

---

Power Options.....	Removable rechargeable nickel metal hydride (NiMH) battery pack, optional alkaline battery pack, or DC Power pack
Battery Level Indicator.....	On-screen icon displays battery level
Interface Connectors.....	All pump computer interface performed via the Dock
Dock Functions.....	Battery charging, USB computer interface (optional), and SmartCal automatic-calibration (optional)
Charging Time.....	5 hours maximum, typical charge times are 2-3 hours

## Appendix H: Charging/Communications Dock

---

The Dock provided with the GilAir Plus charges the pump and optionally provides communications capability for a computer connection and connection to an air flow calibrator for automatic calibration (i.e., SmartCal).

The Dock is available in one, three or five station basic or communication configurations. The basic configuration provides pump charging capability only and does not allow for communications to a PC or air flow calibrator with the pump. The communications configuration enables a USB connection to a PC and use of the Gilian CONNECT pump management system and the connection of an air flow calibrator device. Each supported air flow calibrator device has a unique adapter cable that must be ordered separately. The supported devices and communications cables with part numbers are listed in Section 4.9.2. and Appendix F. See Section 5.10. for further details of the SmartCal feature.

Power is supplied to the Dock through a universal input power supply (100-240 Vac, 50/60Hz) or a car accessory plug. There is no power switch on the Dock as the Dock detects the pump or battery pack when it is placed on the Dock and begins the charging process automatically.

When a NiMH battery pack is used on a dock with version 3.5 or higher of the dock software, and version 2.4 or higher of the pump software the pump can start and run while on the Dock without requiring the use of a DC back. The dock will trickle charge the pump batteries in addition to supplying the power required for operation.

When using the AA replaceable cell pack the pump can be run on the dock, but the dock will not supply power. When using the DC back, the pump can be used while mounted on the Dock.

The pump can be placed on the Dock either turned on or off. If the pump is on, communication will be possible immediately. If the pump is off, it will power up as soon as it detects the Dock, entering a Dock startup phase. If the pump startup is delayed it is acceptable to turn the pump on by pressing the Power button. This can be done without removing the pump from the Dock. A display will show the charge phase, which reports the Dock testing of the battery and the beginning of the charge cycle. After a period of about 20-30 seconds, if the battery is in good condition, the pump will enter the normal startup procedure. If the battery is deeply discharged or malfunctioning, the Dock will attempt to recondition the battery as part of the normal charging cycle; this will cause a slight delay in the startup process. The charging process begins as soon as the pump is placed on the Dock with the NiMH battery pack. The pump initially displays a charging status screen showing 'NiMH analysis' (this message may not appear if the pump is not powered on when mounted on the Dock). When the 'NiMH analysis' process confirms a good battery pack, the Dock will begin to fast charge the battery pack. The red LED on the pump flashes at a fast rate to indicate that fast charging is in process. Once fast charge begins, the pump will take between 10 minutes and 5 hours to complete the main charge operation, depending on the initial charge status of the battery pack. When full charge is detected, the Dock switches to a "top off" charge at a lower charging rate for 20 minutes. This "top off" charge sequence ensures a uniform



full charge in all cells in the battery pack. During the “top off” phase the green LED flashes slowly. At this point, the pump is at nominal full charge and can be removed and used, although it is recommended to wait for the “top off” charge sequence to finish before using the pump to ensure maximum run time. After the “top off” phase completes, the green LED turns to steady green and the Dock continues to charge the battery pack at a trickle charge rate that will continue to hold the battery cells at full charge while the battery pack is on the Dock. The battery pack may be removed and used at any time when the LED is green.

**Note: Each battery is analyzed, charged or reconditioned by the Dock as a result of the Dock’s analysis of that particular battery. Placing five pumps onto a five-unit Dock will often result in different charge patterns for the individual pumps, and they will not necessarily finish the process in the same amount of time. The full charge process can take from 20 minutes to 5 hours, depending upon the condition of the battery. Typical charge times are 2 to 3 hours.**

**Note that if the pump or battery pack remains unused for an extended period of time approximately one month or longer, the battery pack should be reconditioned for maximum run time. Dock the pump or battery pack in the trickle charge status (as indicated by a steady green LED) for a minimum of 12 hours. This will return all of the cells in the battery pack to a uniform full charge condition.**

**DOCK VERSION 3.2, 3.4, 3.5, DISPLAY FOR NIMH BATTERY PACKS:  
(NORMAL CHARGE PROCESS)**

LED Indication	Charge Status
Dock: Brief red flashes every 2 sec Pump: Not on Dock LCD: No LCD display	Waiting for pump or battery to be inserted
Dock: Continuous red Pump: Continuous red LCD: "NiMH Analysis"	Analyzing NiMH battery
Dock: Fast flash red, 5/sec Pump: Fast flash red, 5/sec LCD: "NiMH Fast Charge"	Fast charge
Dock: Flash Green, 2. 5/sec Pump: Flash Green, 2. 5/sec LCD: "NiMH Top Off Charge"	Top off charge
Dock: Continuous green Pump: Continuous green LCD: "NiMH Trickle Charge"	Trickle charge including during run on dock

The following displays for NiMH battery packs indicate when unusual charge conditions have been detected by the Dock.

Unusual charge conditions are caused by deeply discharged cells, aged or damaged batteries or other problems with the NiMH battery pack. The pump displays error messages, generally combinations of messages and multiple LED flashing patterns. The Dock will automatically try to recondition the battery pack as part of the normal charge cycle when unusual charge conditions have been detected. If the charge cycle ends with an alternating Trickle/NiMH Analysis message, the charge cycle has completed but the battery may not have the expected charge capacity and runtime may be diminished.

**DETAIL INDICATIONS:  
(UNUSUAL CHARGE CONDITIONS)**

LED Indication	Charge Status
Dock: Continuous red Pump: Red on long / short off LCD: NiMH Analysis(5 sec) / NiMH Recondition(1 sec)	Repeated analysis cycles, indicating deeply discharged or damaged battery pack. Dock is attempting to solve the problem.
Dock: Continuous red Pump: Red on long /short off LCD: Battery Charge Error(5 sec) / NiMH Trickle Charge(1 sec)	Battery Identification error and/or contact problem detected.
Dock: Continuous orange Pump: 9 red pulses, 1 green pulse LCD: NiMH Recondition(5 sec) / NiMH Trickle Charge(1 sec)	Battery has very low voltage. Dock is attempting to recondition pack.
Dock: Alternating red/green Pump: Fast flash red LCD: Battery Charge Error	Problem detected, Dock will attempt to correct problem.
Dock: Fast flash red 5/sec Pump: Fast flash red/ 1 sec red LCD: NiMH Fast Charge(5 sec) / NiMH Analysis(1 sec)	Battery did not charge normally during standard charge. Capacity may be impaired.
Dock: Flash green 2.5/sec Pump: Flash green / 1 sec red LCD: NiMH Top off Charge(5 sec) / NiMH Analysis(1 sec)	
Dock: Continuous green Pump: green 5 sec / 1 sec red LCD: NiMH Trickle Charge(5 sec) / NiMH Analysis(1 sec)	

The "Battery Charge error" indication happens when the battery type (NiMH, AA, DC) cannot be identified or the connection to the battery is not good. This can often be resolved by removing and remounting the pump/battery to the Dock, and cleaning the contacts on the pump with a rubber pencil eraser (never use a blade or metal tool to clean contacts, contacts may be damaged). It may signal a damaged battery pack.

If the battery is deeply discharged or damaged, a reconditioning step is performed that charges the battery at low current for one hour. This will reform a deeply discharged pack and may help an aging pack. After the reconditioning, the battery is tested again and will reenter the charge sequence on completion. If the battery remains out of specification charging will continue but the message "NiMH analysis" will display during fast charge, top off and trickle to warn that the pack may not meet runtime requirements. If a power interruption occurs with pumps in place, the charge sequence will restart the Dock.

Note that NiMH battery packs may be charged separately on the Dock without being connected to a pump if desired. The same cycle is used as described previously and the LED signals are provided by the LED on the Dock as described in the table above.

### DOCK VERSION 3.2, 3.4, 3.5 DISPLAY FOR REPLACEABLE CELL AND DC PACKS

LED Indication	Charge Stage
Dock: Continuous green Pump: Continuous green LCD: "Replaceable Cell Pack"	Dock has detected a Replaceable Cell pack and is not supplying power.
Dock: Continuous green Pump: Continuous green LCD: "DC Power"	Dock has detected a DC back and is supplying power

The USB connection can be used to interface the pumps held on the Dock to a PC for use with the optional GilAir Plus PC Application. This application transfers event data to a PC database, provides pump management capability including the ability to copy pump setups and allows sampling plans (programs) to be created to control the timing and setting of pump operation. The PC Application is described more fully in the separate GilAir Plus PC Application Manual (P/N 360-0143-01).

## Appendix I: Factory Calibration and Service

---

### U.S.A.

Sensidyne, LP  
1000 112<sup>th</sup> Circle N, Suite 100  
St. Petersburg, Florida 33716

800-451-9444  
+1 727-530-3602  
+1 727-539-0550 [Main fax]  
+1 727-538-0671 [Service fax]  
info@Sensidyne.com  
www.Sensidyne.com

**Manufactured by:**

**Sensidyne, LP**

1000 112<sup>th</sup> Circle N, Suite 100  
St. Petersburg, Florida 33716  
U.S.A.

800-451-9444 • +1 727-530-3602 • [fax] +1 727-539-0550  
www.Sensidyne.com • info@Sensidyne.com



**Intertek**



**Authorized EU Representative**

**Schauenburg Electronic Technologies GmbH**

Weseler Str. 35 · 45478  
Mülheim-Ruhr Germany  
+49 (0) 208 9 99 10 • +49 (0) 208 5 41 10 [fax]  
www.schauenburg.com • international@schauenburg.com

# Gilian®

***SENSIDYNE***®  
*Industrial Health & Safety Instrumentation*

1000 112<sup>th</sup> Circle N, Suite 100 • St. Petersburg, FL 33716 USA  
(800) 451-9444 • +1 (727) 530-3602  
[www.Sensidyne.com](http://www.Sensidyne.com) • [info@Sensidyne.com](mailto:info@Sensidyne.com)